

Pro.2

Providing AV Solutions

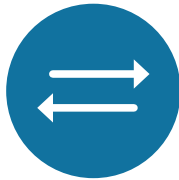

COMMUNICATION



DISTRIBUTION



CUSTOMISABLE

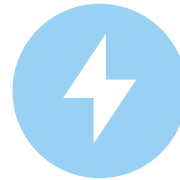

FAST

— 2017 —



FULL PRODUCT BROCHURE
CONNECTING AV HARDWARE

Pro.2

Providing AV Solutions

HIERARCHY OF CONNECTORS

Solves the struggle in finding a particular cable or wall plate. Quite simply, if one end of the lead, or one input or output of a device, ranks higher in the hierarchy of connectors, then you will find that cable or wall plate in that section.

Eg. 1 If you are looking for a DVI to HDMI lead, then you will find it in the HDMI section as HDMI ranks higher than DVI on the hierarchy.

Eg. 2 If a wall plate has a USB and Component connections, then it will be located in the USB category as USB is further up the hierarchy.



DIGITAL AV

- 4-17 HDMI 
- 18-19 DVI 
- 20 DISPLAYPORT 
- 21-22 OPTICAL / TOSLINK 

COMP & COMM

- 24-28 VGA 
- 29-36 USB 
- 37-40 CAT5E/6/6A DATA 
- 41-42 TELEPHONE 
- 43 OTHER - PC (SATA/DB9 etc) 

COAXIAL

- 45-48 'F' TYPE 
- 49-50 PAL 
- 50 BNC 

ANALOGUE AV

- 52-53 PRO AUDIO: XLR SPEAKON 
- 53 SCART 
- 54-56 COMPONENT 
- 57 S-VIDEO 
- 58-60 COMPOSITE (RCA) 
- 61-64 AUDIO (RCA) 
- 64-65 3.5mm 

- 67 WIRELESS AUDIO
- 68-71 AMPS / MULTIROOM / SPEAKER
- 72-75 WALL PLATES
- 76-79 IR DISTRIBUTION
- 80-81 IPHONE / IPAD
- 82 ACCESSORIES & MISC



HDMI OVER IP EXTENDER WITH POE



DISTRIBUTE YOUR AV SIGNALS THROUGH YOUR NETWORK!

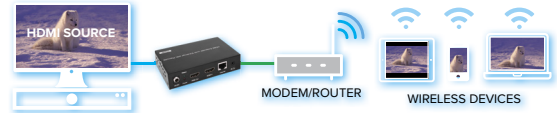

ONE TO MANY! MANY TO MANY!

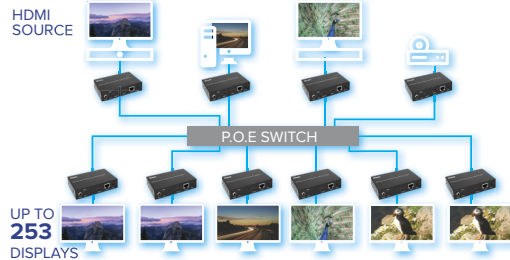

HDMIIPRO CONTENTS:

- 1x Transmitter
- 1x Receiver
- 1x IR-TX cable
- 1x IR-RX cable
- 4x Detachable Mounting Ears
- 2x Phoenix Plugs For RS232 Cable Termination
- 2x Remote Control



This HDMIIPRO HDMI over IP Extender uses advanced H.264 compression which transfers signal using lower bandwidth thus smoother transmission. It supports 120m over single Cat5E/6 cable at point to point. A great HDMI over IP solution for meeting rooms, class rooms and homes etc.

- Supports resolution up to 1080p@60Hz
- With IR remote for source selection. LED front panel showing group ID.
- Complies with TCP/IP protocol, Streaming bit rate is up to 15Mbps
- Supports DHCP for easy IP address assigning and LPCM audio format
- Supports one to one, one to many, many to one, many to many modes.
- Can be powered by either power supply or POE
- HDCP compliant
- Supports PC tool control



NEW	HDMIIPRO	07351065	Tx / Rx Pair	HDMI over IP extender with POE
NEW	HDMIIPPRRX	07351066	Receiver only (Rx)	Spare Receiver for HDMIIPRO

HDMI USB KVM EXTENDER OVER IP



Extends 1080p HDMI signals up to 120m over a single Cat5e/6 cable. 1080p and 720p video compatible, plus 2-channel audio. Built-in DIP switch to change Group ID for multiple displays

- Uses off-the-shelf gigabit IP switches for extension and distribution
- Plug-and-play operation-no programming or setup required
- Traffic can be unicast, multicast or broadcast for different applications
- Can be cascaded for many layers by daisy chain Ethernet switches
- Allows wide-band IR(38-56KHZ) remote control of sources devices
- HDCP Compatible



HDMIKVM	07351027	Tx / Rx Pair	UP TO 120M VIA SINGLE CAT5E/ 6
----------------	----------	--------------	--------------------------------

4-WAY HDMI OVER UTP SPLITTER (WITHOUT IR)

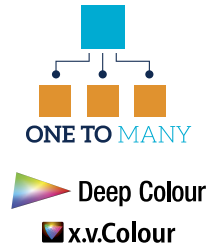

Distributes a single HDMI input signal to four identical UTP outputs.
Supports Resolutions up to 1080p @ 60Hz

- Transmit over 50m single Cat5e/6 cable
- Supports 3D formats and 30/36bit Deep Colour



H4SPC5B	64510090	Splitter only (Tx)	4-WAY HDMI SPLITTER OVER UTP
H4RX4	64510116	Receiver only (Rx)	RECEIVER FOR H4SPC5B SPLITTER

HDMI OVER SINGLE CAT6 EXTENDER



Transmit HDMI signal over 50m via single Cat5e/6
Supports PCM, Dolby Digital, and DTS Digital Surround

- Support high definition resolution up to Full HD 1080p

- Supports 3D formats



NEW	HDC6ECO	07351034	Tx / Rx Pair	BI-DIRECTIONAL HDMI SIGNAL - NO IR
NEW	HDC6L	07351046	Tx / Rx Pair	LOOPING HDMI OUT/EDID/3D - WITH IR

HDMI OVER SINGLE CAT5E/6 EXTENDER



Wall plate high definition HDMI extender kit extends your high definition AV source up to a maximum 60m via CAT5E/6 cables through the wall cavities.

Integrates an infra-red control extender for full controllability from the receiving end. RJ45 connections on the rear of both units makes it for easy connection.

- Up to 60m with 1080P video format
- Supports 3D formats



- Supports DTS-HD Master Audio, Dolby true-HD, and more



NEW	HDC6WP	39893348	Tx / Rx Pair
------------	---------------	----------	--------------

SPC5L SERIES - HDMI OVER UTP SPLITTER WITH IR



These HDMI splitters over single Cat5e/6 enable you to split your source up to 50 metres with IR pass-through. Simply connect the SPC5RX (below) receiver to your destination and you are good to go!

- Provides a local HDMI loop-out for viewing locally or cascading (up to 4 layers! – see diagram over page)
- Supports full HD 1080p, VESA resolution 1920x1200, Dolby TrueHD, DTS-HD Master Audio, and 3D
- Wide-band bi-directional IR (36-56kHz) control
- 3D Full HD 1080p, VESA resolution 1920x1200
- Dolby TrueHD, DTS-HD Master Audio
- EDID DIP-switch

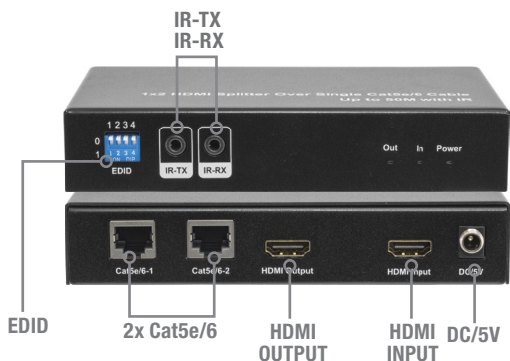

2-WAY H2SPC5L | 64510142



4-WAY H4SPC5L | 64510144



8-WAY H8SPC5L | 64510146

HDMI OVER UTP SPLITTER RECEIVER

Up to 50M + bi-directional IR

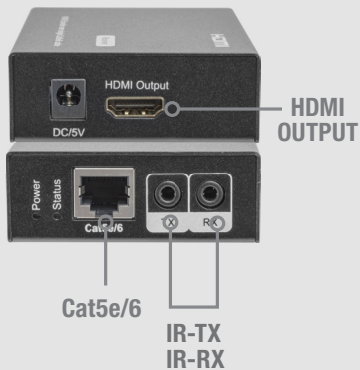

SPC5RX | 64510140

The SPC5RX is the bridge between any Pro2 SPC5L series HDMI over UTP transmitter and your HD display using a single CAT5e/CAT6 cable. Using the included IR transmitter and receiver, you are able to control your source device too!



NEW	H2SPC5L	64510142	Splitter only (Tx)	2-WAY HDMI OVER CAT5 SPLITTER
NEW	H4SPC5L	64510144	Splitter only (Tx)	4-WAY HDMI OVER CAT5 SPLITTER
NEW	H8SPC5L	64510146	Splitter only (Tx)	8-WAY HDMI OVER CAT5 SPLITTER
NEW	SPC5RX	64510140	Receiver only (Rx)	HDMI CAT5 SPLITTER RECEIVER

Examples of Use

2-way Application

Use a H2SPC5L to play content to 3 devices 2x via SPC5RX and 1x via HDMI Loop-out. Use the other models to connect even more devices.

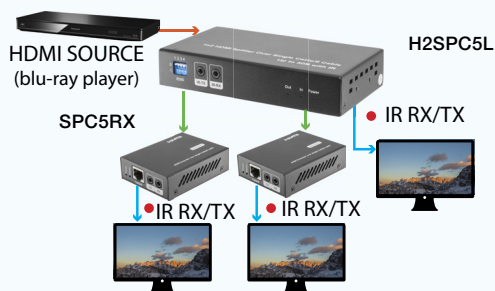

Cascading up to 4 layers

Use a multiple H2SPC5L transmitters to play content to multiple devices via SPC5RX receivers. Connect them together via the HDMI loop-out up to 4 levels. Need more displays? Then consider the 4 or 8 way splitters!

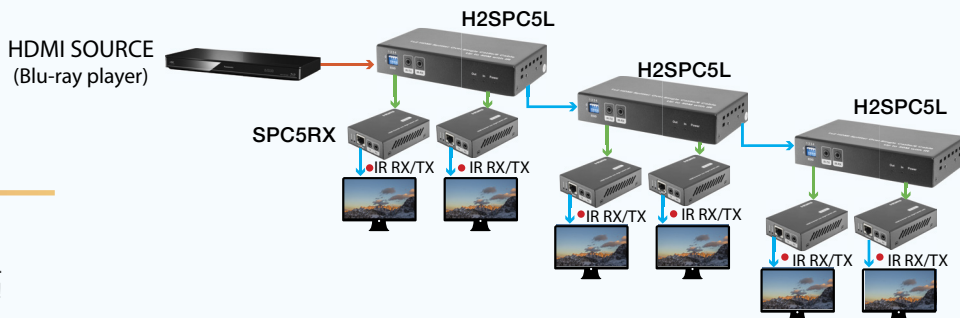

HDMI OVER RG6

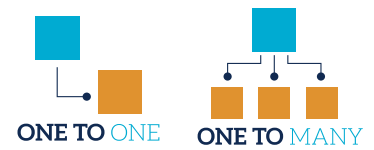

The HDMIRG6 HDMI over coax extender will send 1080p@60Hz HDMI signal with Deep Colour

- HDCP Compliant
- Distribute HD signals in 720p / 1080i / 1080p using a single coaxial cable
- 1080p resolution up to 120m (400ft)

- Create a transmitter/receiver cascade using signal loop-out to extend distance and build up a HDMI splitter system
- High quality metal chassis

ONE-TO-MANY

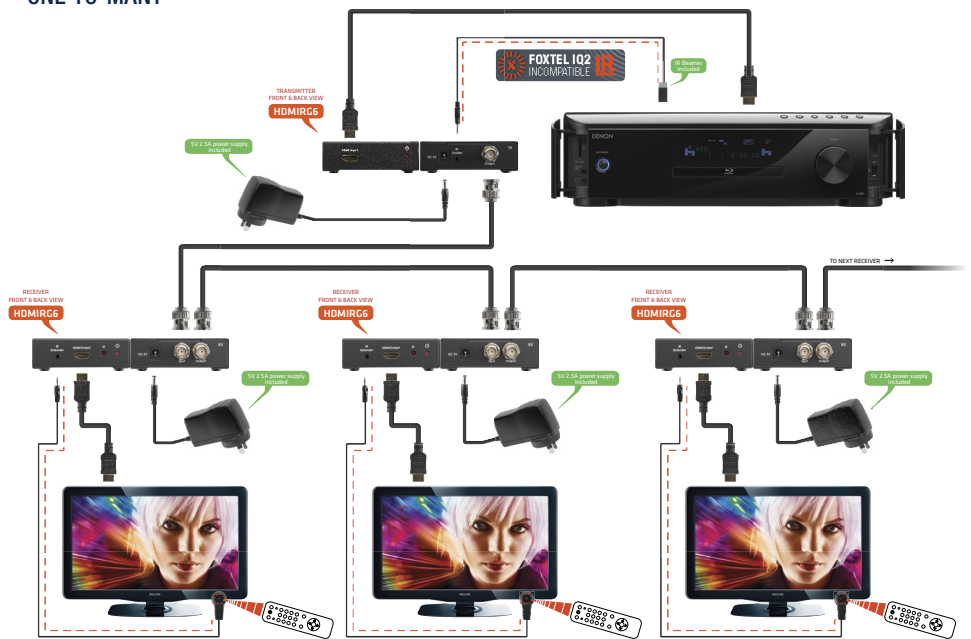

HDMIRG6	07351005	Tx / Rx Pair	HDMI OVER SINGLE COAXIAL CABLE
HDMIRG6S	07351006	Rx Only	SPARE RECEIVER FOR HDMIRG6

HDMI OVER FIBRE



- Extends 1080p HDMI signals up to 20km over optic fibre
- Provides high-resolution image quality
- Ethernet Pass-Through

- Plug-and-play operation—no programming or setup required
- Optical fibre rules out any RF interference
- HDCP Compliant



HDMIFIB	64510350	HDMI OVER FIBRE EXTENDER
----------------	----------	--------------------------

HDMI SELECTOR WITH ARC



Add extra HDMI Inputs to your TV without having to upgrade your entire system!

- Audio Channel return function outputs audio from your TV so you don't have to change inputs on your Receiver/Amplifier
- 3D formats supported
- Supports digital coaxial+optical audio output for non-HDMI sound system
- Supports 1080P Deep Colour

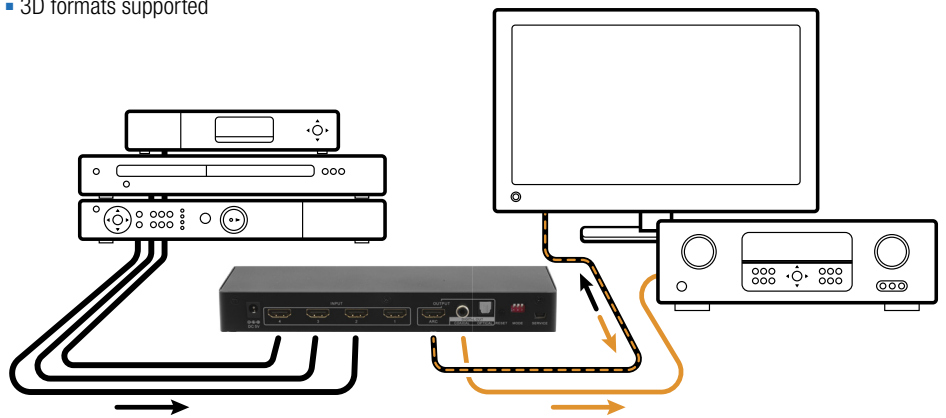

HDMI4AVR 64538014

4-WAY HDMI SWITCH WITH ARC+3D

HDMI SWITCHER/ SPLITTER COMBO



Switches between 4x 3D HDMI inputs and splits simultaneously to 4x 3D HDMI outputs.

- Displays the selected input on up to 4 displays simultaneously
- Supports 3D video formats
- Use panel buttons or remote controller to select input signal

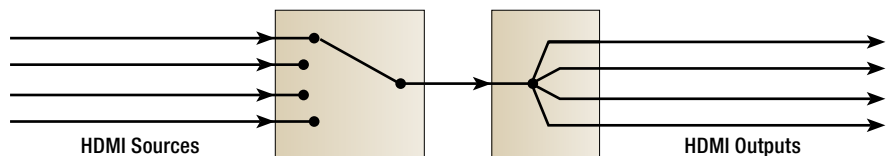

HDMI44 64510325

4-IN 4-OUT HDMI SPLITTER

HDMI SELECTORS



Connects up to three or five HDMI sources to one HDMI display device.

- Maintains 480p, 720p, 1080i and 1080p video formats
- Supports 3D & HDCP
- Maintains highest HDMI single link video resolution and digital audio signal
- No power supply required for short HDMI runs!

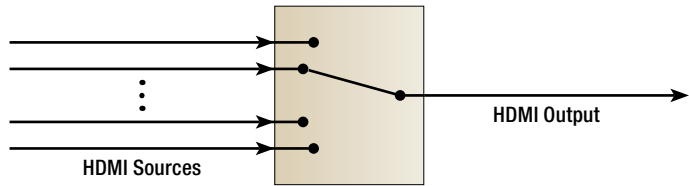

PR01185	64538003	3-way	3-IN 1-OUT MANUAL HDMI SELECTOR
HDMI3SM	64538007	3-way	3-IN 1-OUT MINI HDMI SWITCHER
HDMI5SM	64538009	5-way	5-IN 1-OUT MINI HDMI SWITCHER
NEW HDMI3S4K	64510370	3-way	3-IN 1-OUT REMOTE HDMI/4K SELECTOR

HDMI SPLITTERS

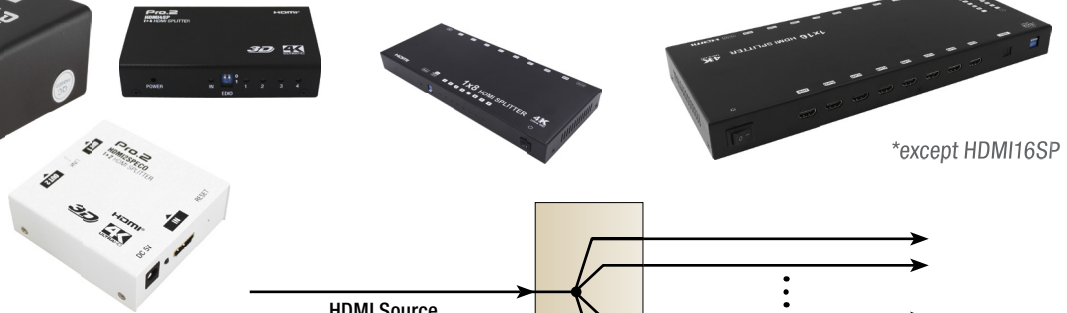

*except HDMI16SP

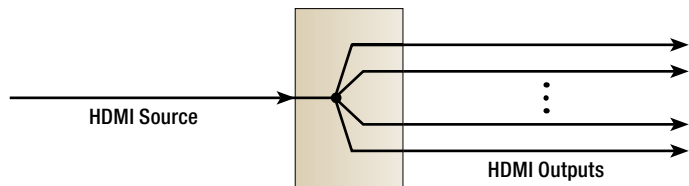

- One input signal can be split to up to 16 HDMI devices



HDMI2SP	64510010	2-way	2-WAY HDMI SPLITTER
HDMI4SP	64510020	4-way	4-WAY HDMI SPLITTER
HDMI8SPEDID	64510032	8-way	8-WAY HDMI SPLITTER WITH EDID
HDMI16SPEDID	64510042	16-way	16-WAY HDMI SPLITTER
HDMI2SPECO	64510008	2-way	2-WAY HDMI/4K SPLITTER

HDMI DISTRIBUTION

HDMI MATRIX SWITCHER



True matrix set-ups allow any source—Blu-ray player, satellite receiver, HD game consoles etc—to be shown on any display connected. For example, you can switch to your Pay TV box on your kitchen

TV while the kids are simultaneously playing a Blu-ray movie on the bedroom TV. You can also view the same source on more than one display!

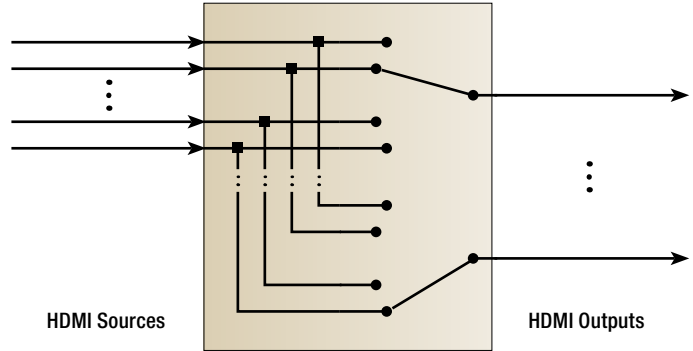

			IN	OUT	RS232	ARC	
NEW	HDMIMX42ARC	64510302	4	2		•	4-IN 2-OUT HDMI MATRIX
NEW	HDMIMX44RS	64510322	4	4	•		4-IN 4-OUT 4K MATRIX
NEW	HDMIMX4422	64510360	4	4	•		2X2 VIDEO WALL

HDMI CONVERTERS



	YH02	30251943	HDMI	←	YPbPr	YPbPr STEREO TO HDMI CONVERTER
	VH03	30251945	HDMI	←	VGA	VGA STEREO TO HDMI CONVERTER
NEW	HVY02	64550185	HDMI	→	VGA/COMPOSITE	HDMI TO VGA/ COMPOSITE
	HC01	64550085	HDMI	→	COMPOSITE	HDMI TO COMPOSITE CONVERTER
	CH01	64550105	HDMI	←	COMPOSITE	COMPOSITE STEREO TO HDMI
	HD02ECO	64550100	HDMI	→	DVI	HDMI TO DVI+AUDIO CONVERTER
	CSH01	64550055	HDMI	←	COMPOSITE	COMPOSITE VIDEO TO HDMI

HDCP2.2 TO HDCP1.4 CONVERTER



HDCP 2.2 is the new copy-protection standard for many modern source devices and streaming services, such as Netflix.

- Compliant HDMI 1.4B.
- Converts HDCP 2.2 to HDCP1.4
- Supports 4Kx2K @ 60Hz / YUV 4: 2:0

This box is perfect for playing your HDCP2.2 content through your HDCP1.4 equipment!

- Supports audio format Dolby / DTS / LPCM
- Supports 3D / CEC



NEW **HDCP2214** 64550155 **HDCP2.2 → HDCP1.4** HDCP2.2 TO HDCP1.4 CONVERTER

HDMI UPSCALER



If your 4K TV manufacturer skimped on the built-in scaling chipset, then your hi-res panel is going to

- 1080p to 4K HDMI scaler
- 4x user selectable operating modes
- 3D 1080P pass-through modes

waste! Take full advantage of your 4K panel and use the SC4K2K to do the upscaling for you!

- Audio extraction via TOSLINK/optical socket
- Full CEC pass-through



SC4K2K 64550115 1080P FULL HD TO 4K SCALER

USB 3.0 TO HDMI ADAPTOR



Easily connect multiple displays to your Laptop, Macbook or Desktop PC in minutes. (One adaptor per display required)

Mirror or Extend large Desktop displays to any HDMI monitor or Projector.

- Uses USB 3.0 connector and also back compatible with USB 2.0
- Connects multiple displays to your PC
- Supports up to 2K resolution 2560x 1440



USB3HDMI 30251949 USB 3.0 TO HDMI ADAPTOR

HDMI ENCODER FOR IP TV

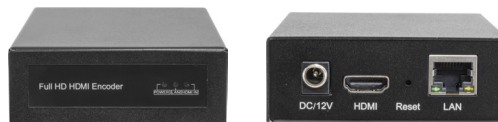

HE01 H.264 HD HDMI encoder is the ideal tool to convert your HDMI resource into IP sharing resource. Great for Multimedia display wall, Video conference, IP TV project etc.

- H.264 encoding
- UDP, HTTP, RTSP,RTMP, Onvif protocol
- MPEG1 audio layer 2
- CBR/VBR rate: 16kbps-16Mbps
- 1000M network interface uses full duplex mode
- Supports up to 720p, 1080p@60Hz HD video input
- Image parameter settings
- WEB interface management authority
- Remote management in WAN(WEB)
- One key to restore factory configuration



NEW **HE01** 43151280 H.264 HDMI ENCODER FOR IP TV

1080P FULL HD VIDEO CAPTURE



The Pro.2 HDVC01 records your HDMI video input—up to 1080P—directly to USB storage in h.264 encoding: no computer required!

- Support HDMI signal source of PlayStation 4, Xbox One and Xbox 360 game play in brilliant 1080p@60Hz with advanced H.264 encoding
- Recording with one-click, easy to use. It doesn't require any set up just click "RECORD" button to record your game play and re-click to stop recording Automatically split the video up to 2GB per file
- Support record video format of MPEG-4 and audio format of RCA L/R 3.5mm microphone input
- Support upscale or downscale to 720P



NEW

HDVC01

09002112

VIDEO RECORDING W/ HDMI INPUT

DESIGNER SERIES



- Only 3.2mm diameter
- 1080P and 4K Ultra HD Compatible
- Advanced 7.1CH Surround Sound

- Full featured HDMI Audio Return Channel (ARC) and Consumer Electronics Control (CEC)

COLOUR

0.5M	HLDS0.5M	27476550	●	SILVER/BLUE DESIGNER SERIES HDMI LEAD
1M	HLDS1M	27476555	●	
2M	HLDS2M	27476560	●	
3M	HLDS3M	27476565	●	
0.5M	HLDS0.5W	27476551	○	WHITE DESIGNER SERIES HDMI LEAD
1M	HLDS1W	27476556	○	
2M	HLDS2W	27476561	○	
3M	HLDS3W	27476566	○	

FLAT LEADS



With gold plated plugs and oxygen free copper conductors, the Contractor Series can deliver

4K Ultra Full HD video and HD audio with minimal loss or interference.

- Functional, flat, low-profile design!
- Supports 3D, 4K and Deep Colour formats

- Supports ARC, CEC and Ethernet over HDMI



0.5M	HLVF0.5	27476000		FLAT CONTRACTOR SERIES LEADS
1M	HLVF1	27476002		
2M	HLVF2	27476003		
3M	HLVF3	27476004		
5M	HLVF5	27476006		

CONTRACTOR SERIES

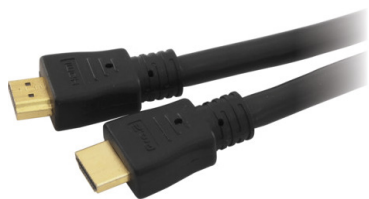











With gold plated plugs and oxygen free copper conductors, the Contractor Series can deliver

4K Ultra Full HD video and HD audio with minimal loss or interference.

- Supports 3D (10m & 15m Lengths), 4K (10m & 15m Lengths) and Deep Colour formats

- Supports Ethernet over HDMI (10m & 15m Lengths), ARC, and CEC

WITH BOOSTER

	10M	HLVR10	27476011		ROUND CONTRACTOR SERIES
	15M	HLVR15	27476016		
	20M	HLVR20	27476020		•
	30M	HLVR30	27476030		•
	40M	HLVR40	27476040		•









CONTRACTOR SERIES HDMI LEADS

At Pro.2, we pride ourselves on providing quality products with good value for money. When it comes to HDMI leads, you want to be sure you are getting the very best, without over paying for features that you don't need, and at the end of the day, don't really make a difference.

Our Contractor Series HDMI Leads all have their test results online so you can see how they perform and conform!

HDMI LEADS



	2M	HLV1130	27331130		MINI HDMI TO HDMI LEAD
	1M	HLV1150	27331150		HDMI LEAD WITH SWIVEL PLUG
	2M	HLV1165	27331165		MICRO HDMI TO HDMI LEAD
	0.2M	LC6150	27726150		MINI DISPLAYPORT TO HDMI SOCKET
	2M	LC6152	27726152		
	2M	LC6153	27726153		MINI DISPLAYPORT TO HDMI PLUG
	2M	LC6210	27726210		DISPLAYPORT PLUG TO HDMI PLUG
	0.5M	HLV1145	27331145		HDMI EXTENSION LEAD

HDMI LEADS

EASYLOCK HDMI LEAD



Video online

LIFE TIME WARRANTY!



The unique and patented EasyLock HDMI locking cable can be used with ANY standard HDMI device to prevent accidental disconnection. Unlike other HDMI locking solutions, the

EasyLock HDMI cables will work with any brand of TV, monitor, set top box, media player, switch, splitter, extender or wall plate.

- World's first ATC certified locking HDMI cable
- Supports HDMI 2.0 and HDMI 1.4
- Supports all the latest 4K Ultra HD TV's with resolution up to 3840 x 2160 (2160p)
- Green and Red colour indicators to show lock status
- 24k gold plated corrosion resistant connectors for maximum conductivity and low signal loss

NEW	0.5M	ELHH005	27475800	LOCKING CABLE HDMI2.0 4K
NEW	1M	ELHH010	27475801	
NEW	1.5M	ELHH015	27475802	
NEW	2M	ELHH020	27475803	
NEW	3M	ELHH030	27475804	
NEW	5M	ELHH050	27475805	
NEW	7.5M	ELHH075	27475806	
NEW	10M	ELHH100	27475807	

EASYLOCK DVI LEAD



NEW	0.5M	ELHD005	27331250	EASYLOCK HDMI TO DVI LEAD
NEW	1M	ELHD010	27331251	
NEW	2M	ELHD020	27331252	
NEW	3M	ELHD030	27331253	
NEW	0.5M	ELHDS005	27331260	EASYLOCK HDMI-DVI SOCKET

EASYLOCK HDMI EXTENSION



NEW	0.5M	ELHHS005	27331170	EASYLOCK HDMI EXTENSION
NEW	1M	ELHHS010	27331171	
NEW	2M	ELHHS020	27331172	
NEW	3M	ELHHS030	27331173	

HDMI ADAPTORS LEADS



HLV1140	27331140	HDMI PLUG TO 2X HDMI SOCKETS*
HV02	30251968	HDMI TO VGA

*HDCP non-compliant

HDMI TO DVI LEADS

GOLD
PLATED CONNECTORS



- DVI-D Dual Link cable
- Ferrite beads on both ends to minimise interference
- Gold Plated copper for lower contact resistance
- Foamed PE Insulation ensuring high speed propagation and low signal loss

0.3M	HLV0981	27330981	HDMI TO DVI LEAD
1M	HLV0983	27330983	
2M	HLV0986	27330986	
3M	HLV0987	27330987	
5M	HLV0989	27330989	
10M	HLV0991	27330991	
15M	HLV0993	27330993	

HDMI SWIVEL ADAPTOR

GOLD
PLATED CONNECTORS

If you are having trouble making an easy and accessible HDMI connection to your AV components, this adaptor might be the solution for you.

- 180° swivel and rotation
- Can be used with any HDMI cable
- Gold plated connectors
- HDMI plug to HDMI socket



PA4300	30254300	HDMI SWIVEL ADAPTOR
---------------	----------	---------------------

HDMI ADAPTORS

HDMI ADAPTORS

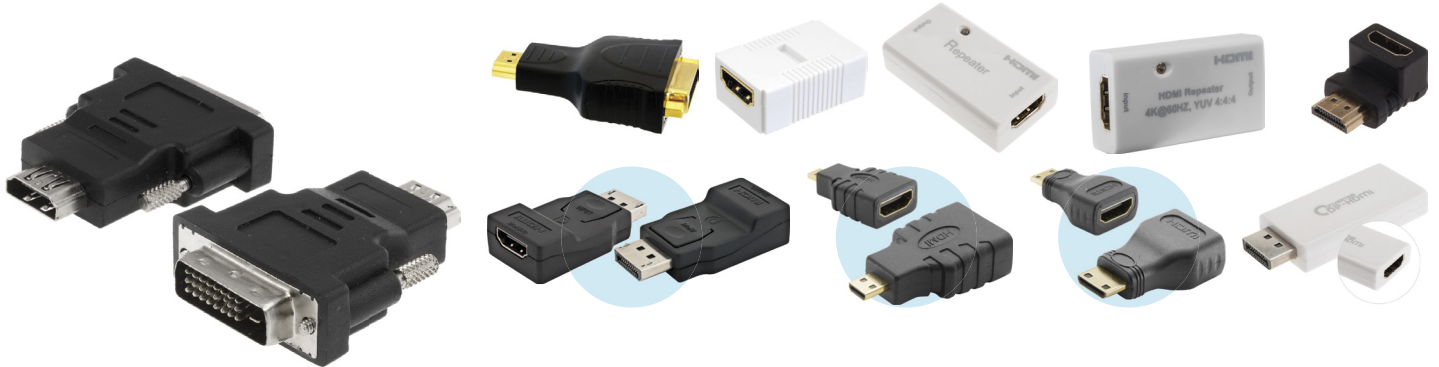

PA4270	30254270	HDMI SOCKET TO DVI-D PLUG
PA4275	30254275	DVI SOCKET TO HDMI PLUG
PA4280	30254280	HDMI JOINER
HR02	30254288	HDMI REPEATER
NEW HR04	30254289	HDMI2.0 4K2K REPEATER
PA4295	30254295	HDMI RIGHT ANGLE ADAPTOR
PA4350	30254350	DISPLAYPORT TO HDMI ADAPTOR
PA4365	30254365	MICRO HDMI PLUG TO HDMI SOCKET
PA4370	30254370	MINI HDMI PLUG TO HDMI SOCKET
DP2HDMI	64550080	DISPLAYPORT PLUG TO HDMI SOCKET SUPPORTS AMD RADEON EYEFINITY TECHNOLOGY

MHL ADAPTOR



Connect your MHL (Mobile High-Definition Link) enabled mobile device to your big

screen's HDMI input while a secondary micro-USB / MHL port enables charging!

- Supports HD audio and video connectivity
- HDMI output resolution support: up to 1080p @ 24/30Hz

- Comes with MHL-to-MHL (Micro-USB to Micro-USB) lead
- Requires device to support 5-pin MHL output



MHL2HDMI	30251970	MHL TO HDMI ADAPTOR
-----------------	----------	---------------------

HDMI WALL PLATES



Most of our wall plate feature a flexible lead on the rear HDMI socket, allowing easy installation and allows natural fall of cables in-wall, relieving tension on the wall socket.

Compliments Clipsal 2000 plate design (except PRO1181RF & PRO1258A)



		HDMI	VGA	USB	3.5MM	YPbPr	CBVS	RF
HDMI1H	39893299	1x						HORIZONTAL
HDMI1FLEX	39893300	1x						VERTICAL
HDMI2FLEX	39893303	2x						VERTICAL
PK3304	39893304	1x		•				VERTICAL
PRO1258A	39893343	1x	•			•		Vertical
PRO1310	39893375	1x	•	•	•		•	Vertical
PRO1345	39893400	1x	•	•	•			Horizontal
PRO3420	39893420	1x	•					Vertical
PRO3425	39893425	1x	•	•	•			Horizontal

HDMI CLIPSAL INSERTS



PK4700	30634700	HDMI CLIPSAL RIGHT-ANGLE INSERT
PK4702	30634702	HDMI CLIPSAL INSERT
PK4706	30634706	FLEXIBLE HDMI CLIPSAL INSERT
NEW PK4910	30634910	HDMI KEYSTONE INSERT RIGHT-ANGLE INSERT

DVI-D LEADS

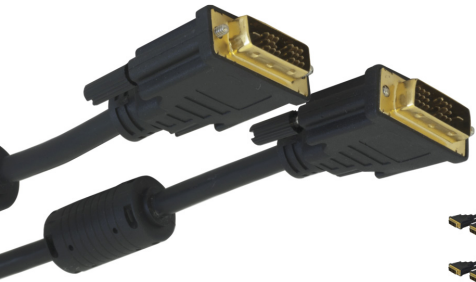

DVI-D (Single Link)

- DVI-D Dual Link cable
- Ferrite beads on both ends to minimise interference
- Gold Plated copper for lower contact resistance

- Foamed PE Insulation ensuring high speed propagation and low signal loss



0.3M	HLV0969	27330969	DVI-D LEAD
1M	HLV0970	27330970	
2M	HLV0973	27330973	
3M	HLV0975	27330975	
5M	HLV0976	27330976	
10M	HLV0979	27330979	
15M	HLV0980	27330980	

DVI ADAPTOR LEADS



30CM	LC6094	27726094	DVI-I PLUG TO VGA + DVI-I
30CM	LC6096	27726096	DVI-I PLUG TO 2X VGA
0.2M	LC6160	27726160	MINI DISPLAYPORT PLUG TO DVI SOCKET
2M	LC6162	27726162	
2M	LC6163	27726163	MINI DISPLAYPORT PLUG TO DVI PLUG

DVI ADAPTORS



PA4245	30254245	VGA SOCKET TO DVI-I PLUG
PA4250	30254250	DVI SOCKET TO SOCKET
PA4355	30254355	DISPLAYPORT TO DVI ADAPTOR

DISPLAYPORT LEADS



The Mini DisplayPort is a miniaturized version of the DisplayPort interface. It is used in revisions of the MacBook, MacBook Air, and MacBook Pro notebooks, iMac, Mac Mini, and Mac Pro

desktops, Xserve servers, and 24-inch Apple Cinema Display. Also in Toshiba Satellite Pro S500, Tecra M11, A11, S11, HP Envy 14 and 17 notebooks.

- Nickel plated plugs
- Colour: White

- RoHS compliant



0.2M	LC6170	27726170	MINI DISPLAYPORT PLUG TO VGA SOCKET
2M	LC6172	27726172	MINI DISPLAYPORT PLUG TO VGA SOCKET
2M	LC6190	27726190	MINI DISPLAYPORT PLUG TO PLUG LEAD
2M	LC6216	27726216	DISPLAYPORT PLUG TO PLUG LEAD

MINI DISPLAYPORT

Commonly associated with Post-2008 Apple computers, Mini Display Ports replaced the previously fitted Mini-DVI ports. Mini DisplayPort is capable of driving resolutions up to 2560x1600 commonly used by 30" monitors. The Mini DisplayPort connector has recently been adopted by the new Thunderbolt protocol and is still backwards compatible with Mini DisplayPort. However Mini DisplayPort adaptors and cables cannot be used for Thunderbolt purposes since active cabling technology is used to enable the high 10Gbps data rates.

DISPLAYPORT ADAPTORS



DisplayPort is a digital display interface standard put forth by the Video Electronics Standards Association (VESA) since 2006. It defines a royalty-free,

digital audio/video interconnect, intended to be used primarily between a computer and its display monitor, or a computer and a home-theatre system.

- DisplayPort 20pin plug to VGA 15pin socket
- Nickel plated plug

- RoHS compliant



PA4360	30254360	DISPLAYPORT PLUG TO VGA SOCKET ADAPTOR
---------------	----------	--

DIGITAL-ANALOGUE CONVERTERS



PRO1259	64550001	TOSLINK S/PDIF	→	ANALOGUE STEREO	DIGITAL TO ANALOGUE CONVERTER WITH DIGITAL LOOP-OUT
PRO1262	64550010	TOSLINK S/PDIF	←	ANALOGUE STEREO	ANALOGUE TO DIGITAL CONVERTER WITH SELECTABLE SAMPLE RATE
PRO1287	64550015	TOSLINK	↔	S/PDIF	DIGITAL CONVERTER
PRO1298	64550020	TOSLINK S/PDIF ANALOGUE	↔	TOSLINK S/PDIF ANALOGUE	UNIVERSAL DA / AD / DD CONVERTER WITH INPUT SELECT

USB / TOSLINK / S/PDIF DAC



The converter takes a Toslink (optical), SPDIF (coaxial) or USB digital audio source and converts it to standard analogue left and right stereo audio.

- Inputs: USB / Toslink optical / SPDIF coaxial (Switchable)
- Built-in amp with volume control
- Outputs: left and right stereo audio RCA and 3.5mm stereo headphone jack
- Plug and play—requires no additional drivers or software

DAC32	64550035	DIGITAL AUDIO CONVERTER		
--------------	----------	-------------------------	--	--

DAC WITH DOLBY/DTS



High quality DAC converts S/PDIF & TOSLINK (PCM, DTS, & Dolby formats) to Analogue output



		INPUT	OUTPUT	
DAC212	64550090	TOSLINK S/PDIF	2ch	DIGITAL TO ANALOGUE DECODER
DAD51	64550095	1X TOSLINK 2X S/PDIF STEREO ANALOGUE	5.1ch	DIGITAL AUDIO DECODER

DIGITAL EXTENDER



Listen and control digital audio sources up to 200m over a single Cat5e/6 cable

- Transmit digital signals with a single Cat5e or Cat6 cable
- Up to 200 metres distance
- IR return
- Selectable input—TOSLINK or S/PDIF
- Supports multichannel audio

PR01362D 07350047 DIGITAL AUDIO CAT5 EXTENDER

TOSLINK SWITCHER



3-in 1-out Powered TOSLINK Switch with Remote Control. Attach up to three Optical Toslink audio

sources to a single receiver and select one input source to be sent to one of three connected devices.

- Audio formats supported: LPCM2.0 / DTS / Dolby-AC3
- Output distance is up to 40m
- The input selection can be made via remote or button on unit
- Supports signal re-timing

NEW PR01376 64538019 TOSLINK DIGITAL AUDIO SWITCH

SWIVEL RIGHT-ANGLE ADAPTOR



PA1908 30251908 TOSLINK SWIVEL RIGHT-ANGLE ADAPTOR

TOSLINK: "CONSUMER OPTICAL FIBRE"

TOSLINK (or optical digital) inputs and outputs are found on the back of most consumer AV equipment such as CD players, DVD players, and AV receivers. They allow the transport of high bit-rate digital audio (including multi-channel audio) over a single lead. Although utilizing an identical digital signal as S/PDIF coaxial digital connections, TOSLINK uses light instead of electricity making it inherently impervious to EMI.

Often referred to as "fibre optic" cable, it is more accurately called TOSLINK (from Toshiba Link), setting it apart from other optic fibre technologies and connections—most notably "fibre patch leads" which are commonly used in high-speed computer networking infrastructure, TV broadcast equipment and telecommunications, and which use vastly different connectors.

PREMIUM TOSLINK LEAD

- High grade optical cable for audio
- Double protected, super flexible cable
- Overall Diameter: 6.0mm



Length	Model	Part Number	Product Name
0.5M	LA0469	27330469	PREMIUM TOSLINK LEAD
1M	LA0470	27330470	
2M	LA0471	27330471	
3M	LA0473	27330473	
5M	LA0474	27330474	
10M	LA0477	27330477	
15M	LA0478	27330478	
20M	LA0480	27330480	

FIBRE PATCH LEADS

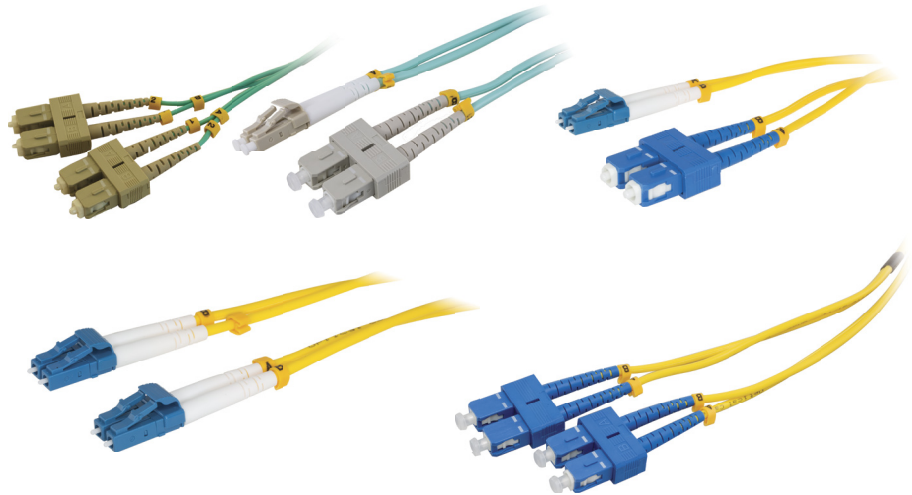
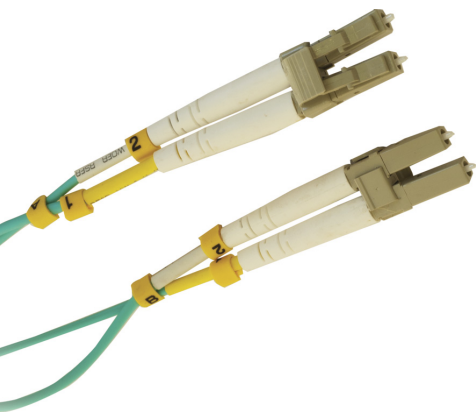

Pro2 fibre patch leads ensure the performance and reliability of servers, storage, and network switches and are built using the highest-quality fibre cable and connectors.



	2M	FP7620	27727620	LC to LC	DUPLEX MODE - OM3	LC-LC FIBRE PATCH LEAD
	3M	FP7622	27727622			
	5M	FP7624	27727624			
	2M	FP7660	27727660	SC to SC		SC-SC FIBRE PATCH LEAD
	2M	FP7750	27727750	LC to SC		LC-SC FIBRE PATCH LEAD
NEW	2M	FP7640	27727640	LC to LC	DUPLEX MODE - OM4	LC-LC FIBRE PATCH LEAD
NEW	3M	FP7642	27727642			
NEW	2M	FP7770	27727770	LC to SC		LC-SC FIBRE PATCH LEAD
NEW	2M	FP7602	27727602	SC to LC	SINGLE MODE	SC-LC FIBRE PATCH LEAD
NEW	2M	FP7604	27727604	LC to LC		LC-LC FIBRE PATCH LEAD
NEW	3M	FP7606	27727606			
NEW	5M	FP7608	27727608			
NEW	2M	FP7600	27727600	SC to SC		SC-SC FIBRE PATCH LEAD

FIBRE CABLE ROLL

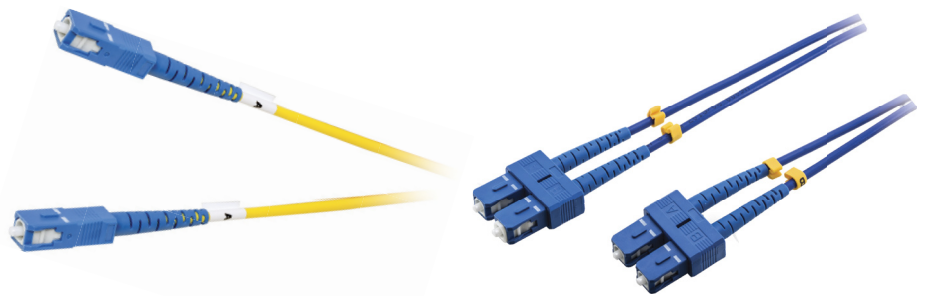

NEW	100M	FIB100SF	05060700	SC-SC FIBRE CABLE ROLL - SINGLE	
NEW	100M	FIB100M	05060860	SC-SC FIBRE CABLE ROLL - DOUBLE	
NEW	150M	FIB150M	05060880		
	200M	FIB200M	05060900		
NEW	250M	FIB250M	05060920		
	300M	FIB300M	05060960		
NEW	100M	FIB1000D	05060750	SC-SC FIBRE CABLE ROLL - OUTDOOR DOUBLE	

COMPUTER & COMMUNICATIONS

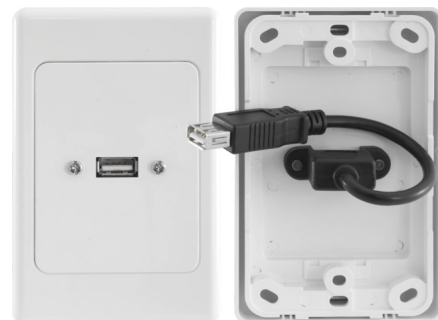
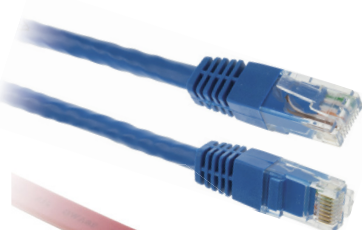

- 24-28 VGA 
- 29-36 USB 
- 37-40 CAT5E/6/6A / DATA 
- 41-42 TELEPHONE 
- 43 OTHER - PC (SATA/DB9 etc) 

2:4 VGA MATRIX



Perfect for bars, club houses, and function spaces; distribute two PC sources up to four different zones independently!

- Two PC inputs with 'PC On' indicator
- Four outputs/zones each feature source selector switch with indication LED
- Boosts signals for transmission up to 65m for VGA and 100m for Audio
- 2x VGA inputs / 4x VGA outputs
- 2x Audio Inputs / 4x Audio outputs (3.5mm Stereo Jack)

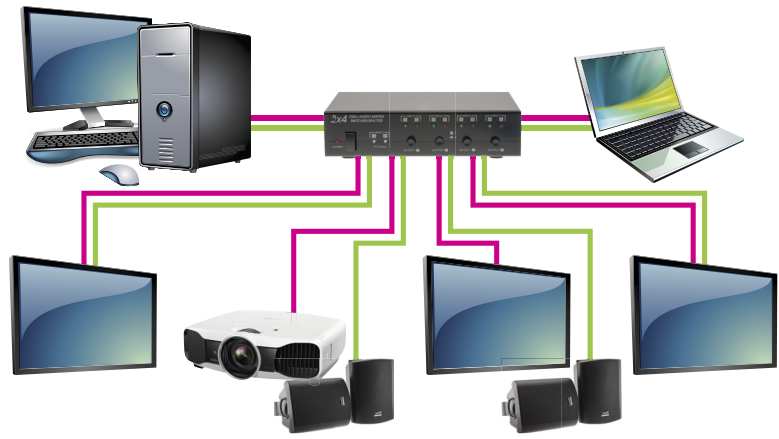

— Video (VGA)
— Audio (3.5mm Stereo)



PRO1338 00760652

2-IN 4-OUT VGA + AUDIO MATRIX

4-ZONE VGA OVER UTP EXTENDER



- Distribute a VGA+Audio signal via single UTP CAT5/5e up to 4 zones (8 outputs)
- Transmission Distance up to 300m (1000ft) via UTP CAT5/5e
- With the loop-out function on the receiver, it can be set up more than just 4 zones.
- Provides 4x RJ45 outputs for transmission

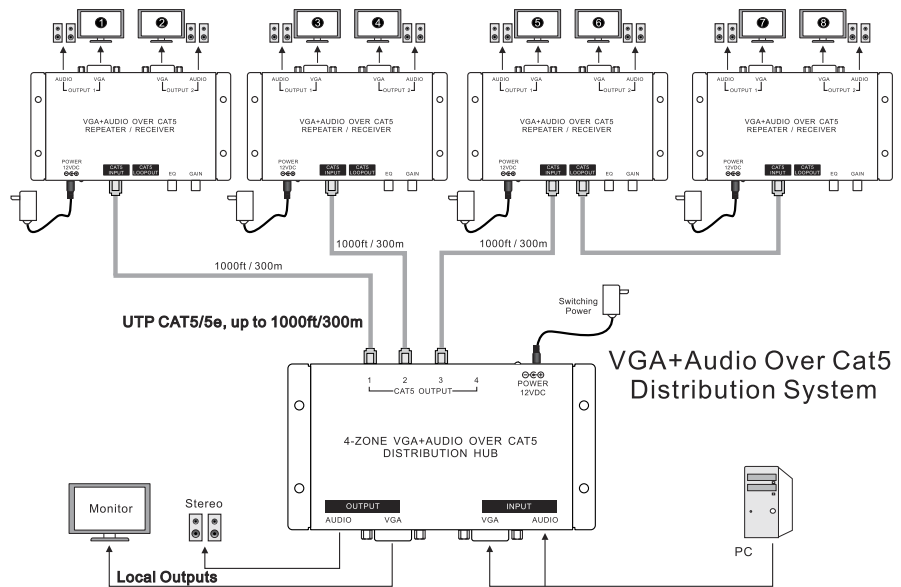

PRO1270 39894094

Tx + Rx Kit

VGA & AUDIO OVER CAT5 BALUN PAIR



PRO1270S 39894096

Rx only

SPARE/EXTRA RECEIVER FOR PRO1270

4-WAY VGA SPLITTER



- Video Bandwidth: >500MHz
- Supported Resolutions: VGA, SVGA, XGA, SXGA, UXGA, QXGA, WUXGA, WQXGA
- Gain and EQ Adjustments
- Input/Output Connector: HD-15 Female



PRO1296 00760650

4-WAY VGA + PC AUDIO SPLITTER

PREMIUM VGA LEADS



This super VGA lead is known as the best in the industry as the 3 Coax + 9 wiring plug configuration, which can minimise the quality

loss over long distances, plus two ferrite filters at both ends to reduce interference.

- 3 Coax + 9 wiring configuration
- Ferrite filters at both ends
- Ø8.5mm outer diameter (AWG28)
- Black dentate cable with PVC jacket
- HD15 plug to HD15 plug



0.5M **LC1050** 27721050

PREMIUM VGA LEAD



1M **LC1060** 27721060



2M **LC1070** 27721070



3M **LC1080** 27721080



5M **LC1100** 27721100



10M **LC1110** 27721110



15M **LC1120** 27721120



20M **LC1130** 27721130



25M **LC1140** 27721140



30M **LC1150** 27721150



40M **LC1160** 27721160

PREMIUM VGA LEADS WITH AUDIO



HD15 VGA plug + 3.5mm stereo jack plug to HD15 plug + 3.5mm stereo plug

- Transmit video signals and stereo audio using the one cable
- Ideal for connecting a PC or laptop to a projector



2M **LC1370** 27721370

VGA & AUDIO LEAD WITH HD15 PLUG & 3.5MM STEREO PLUG



3M **LC1380** 27721380



5M **LC1400** 27721400



10M **LC1410** 27721410



15M **LC1420** 27721420

INSTALLER VGA LEADS



This VGA lead is designed to pass through the wall easily as you only need to drill a DIN plug size hole on your wall instead of big VGA plug size hole.

- 3 Coax + 9 wiring configuration—known as the best quality in the industry
- Ferrite filters at the end minimises interference
- HD15 plug to HD15 plug
- DIN13 Connector: Ø18.5mm



2M	LC1500	27721500
3M	LC1510	27721510
5M	LC1530	27721530
10M	LC1540	27721540
15M	LC1550	27721550

INSTALLER VGA LEAD WITH DIN13 INTERCONNECT

VGA EXTENSION LEAD



This super VGA lead is known as the best in the industry as the 3 Coax + 9 wiring plug configuration, which can minimise the quality

loss over long distances, plus two ferrite filters at both ends to reduce interference.

- 3 Coax + 9 wiring configuration
- Ferrite filters at both ends
- Ø8.5mm outer diameter (AWG28)
- Black dentate cable with PVC jacket
- HD15 plug to HD15 plug



1M	LC1210	27721210
2M	LC1220	27721220
3M	LC1230	27721230
5M	LC1250	27721250
10M	LC1260	27721260
15M	LC1270	27721270
20M	LC1280	27721280
25M	LC1290	27721290
30M	LC1300	27721300
40M	LC1310	27721310

VGA EXTENSION LEAD PLUG TO SOCKET

STANDARD VGA LEADS

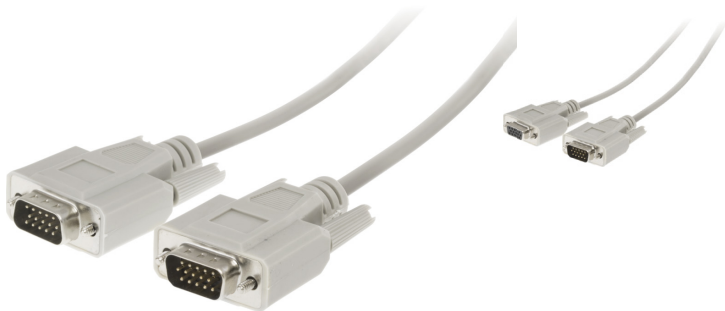

2M	LC1000	27721000	M/M	HIGH DENSITY VGA PLUG TO PLUG LEAD
2M	LC1010	27721010	M/F	HIGH DENSITY VGA PLUG TO SOCKET LEAD

SLIM VGA LEADS



Our slim & flexible low loss coaxial (3 coax + 9 control wire) cables are ideal for short run applications (up to 5 metres)

- 3+9 wiring configuration
- Ferrite filters at both ends
- Slim cable for maximum flexibility



15cm	LC6098	27726098	SLIM VGA SOCKET TO SOCKET
2M	LC2010	27722010	SLIM VGA PLUG TO PLUG LEAD
3M	LC2012	27722012	SLIM VGA PLUG TO PLUG LEAD
5M	LC2025	27722025	SLIM VGA PLUG TO PLUG LEAD

VGA TO RGB/HV LEAD

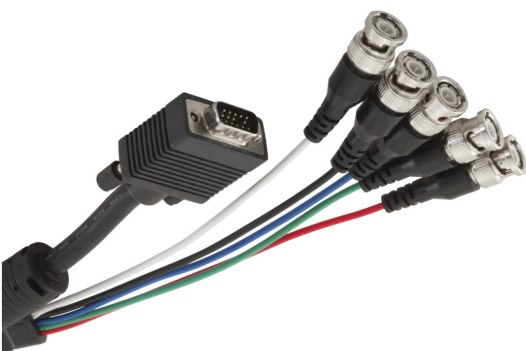

- Colour coding for easy identification
- Red, blue, green, horizontal, and vertical sync
- Fully braided and shielded
- Ferrite cores on each end for noise suppression



2M	LV1560	27471560	VGA PLUG TO 5X BNC PLUGS LEAD
----	---------------	----------	-------------------------------

VGA TO YPBPR LEADS



- New VGA to Component lead
- Featuring a high density 15 pin plug to 3 x Component RCA.



- Designed to be used from DVD to projector with switchable RGB or component video input



2M	LV5182	27475182	VGA TO COMPONENT VIDEO
5M	LV5184	27475184	VGA PLUG TO COMPONENT

VGA ADAPTOR LEADS

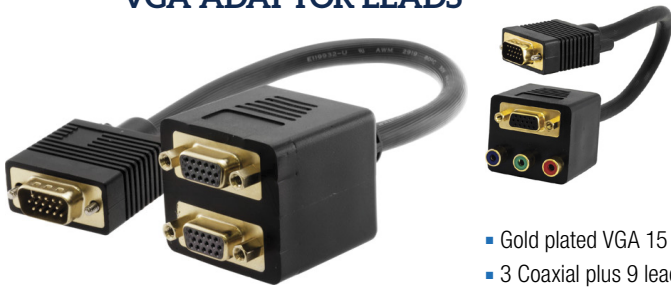

- Gold plated VGA 15 pin connector
- 3 Coaxial plus 9 lead



30CM	LC6090	27726090	VGA PLUG TO 2X VGA SOCKET
30CM	LC6092	27726092	VGA PLUG TO 3X RCA + VGA

RIGHT-ANGLE ADAPTOR



PA4305	30254305	Upwards	VGA RIGHT-ANGLE UPWARDS ADAPTOR
PA4310	30254310	Downwards	VGA RIGHT-ANGLE DOWNWARDS ADAPTOR

VGA WALL PLATES



			VGA	3.5MM	USB	S-VID	CBVS	RCA L/R	H/V
	PK3307	39893307	1x	•					H
	PK3309	39893309	1x*	•					H
	PR01277	39893350	1x	•			•	•	H
	PR01279	39893355	1x		•			•	V
	PR01280	39893360	1x	•		•	•		V
	PR01309	39893370	1x	•	•		•	•	H
	PR01314	39893385	1x	•	•				H

*Right-angle VGA socket

4-PORT USB EXTENDER HUB



The PRO1354 extends a USB connection up to 50m using CAT5e/6 cable. Each extender consists

of a local unit that connects to a computer, and a remote unit that connects to up to four USB devices

- Supports USB transmission speeds up to 480 Mbps
- Built-in 4-port Hub on receiver unit
- Link indicator on receiver unit
- Power Supply: 5VDC/3A (included)



PRO1354 09051710 4-PORT USB OVER CAT5/6 EXTENDER

CURRENT/VOLTAGE METER



- Easily measure the USB port of the output voltage and the device current
- Plug and play, light and handy easy to carry
- Available for every USB electronic product
- Suitable for factories, laboratories and users

CVT201 09050725 USB CURRENT VOLTAGE METER

CARD READERS



- Includes mini USB-A to mini-B lead
- Multi-Card Reader/ Writer
- Supports: CF I / CF II/ CF III/ CFIV/ Microdrive,

SDHC2.0/SD/ MMC/ MiniSD/ MicroSD (Transflash)/ RS-MMC/ MMC4.2/ RS-MMC4.2/ MMC Micro, XD 1.21, MS/ MS Pro/ MS Duo

CR85 09050630 85-IN-1 USB CARD READER

ON-THE-GO ADAPTOR



Transfer data, pictures or videos between your Samsung Galaxy device to SD card,

Memory Stick, USB flash drives and send HDMI to HDTVs with one simple adaptor

- Samsung Galaxy S3/S4/Note 2/Note 3 compatible 11-pin OTG adaptor
- Reads SD & MicroSD memory cards
- USB port for keyboards and flash drives
- Output video and audio to HDTVs via HDMI connector—up to 1080p

OTGMHLCR 43080130 MHL / OTG CARD READER

USB PC ADAPTORS



Provides PCs, notebook PCs and handheld computing devices an external RS232/Parallel port

- Full compliance with USB v2.0
- OS Compatibility: Windows 98 / ME / 2K / 2003 / XP / Linux and Mac OS 8.6/9/10.



45cm	USB-RS232	27727280	DB9	USB TO SERIAL (RS232)
1.8M	USB-DB25	27727290	DB25	USB TO PARALLEL (PRINTER)

USB ETHERNET ADAPTORS



If your PC or Netbook does not have an Ethernet port, but you need the reliability or speed of a wired network connection, then the Pro.2 USB Ethernet adaptors are convenient and compact solutions. Supported by most computers (and

operating systems) without installation of special drivers, they are a quick and simple way of joining a LAN to gain internet access, print via network printers, stream media, and access shared files.



UPRS2	43151245	USB 2.0	10M/100M	USB ETHERNET ADAPTOR
UPRS3	43151250	USB 3.0	Gigabit	

USB SOUND-CARD



Eliminate the need for a traditional sound card with PA2295 USB to Mic & Headphone audio adapter. It's simple to use, simply plug and play!

- USB 2.0 interface
- Speaker/Headphone out jack
- Microphone in jack



PA2295	30252295			USB MIC AND HEADPHONE ADAPTOR
---------------	----------	--	--	-------------------------------

4-PORT HUB



- 4 ports, and power up to 500mA each port
- Active or Passive operation—power input for optional external power supply
- No need for drivers or software
- USB Version 2.0



HUB4 09050715

4-PORT USB 2.0 HUB

USB C HUB WITH 4X USB A SOCKETS



USB-C hub plug into USB-C sockets and converts and extends USB-C connection to 4 regular

USB-A sockets. USB 3.0 high speed connection and back compatible with all USB2.0 devices

- USB3.1 interface, supports transfer rate up to 10GB
- Back compatible with USB 1.1 /2.0/3.0
- Plug and play
- Supports full-speed (480Mbps) and low-speed (12Mbps) USB device profiles
- No driver needed for Windows XP/ Vista/7/8/10 & MacOS, Linux



NEW HUB3C4 09050740 4-PORTS

USB3.0 LEADS



- Nickel plated connectors
- Version: USB3.0



1M	LC7251	27727251	USB3.0 USB-A PLUG TO USB-A PLUG
1M	LC7256	27727256	USB3.0 USB-A PLUG TO USB-A SOCKET
1M	LC7261	27727261	USB3.0 USB-A PLUG TO USB-B PLUG
1M	LC7266	27727266	USB3.0 USB-A PLUG TO MICRO USB-B LEAD

USB LEADS

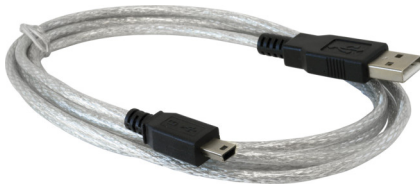

COLOUR



2M	LC7186	27727186	●	USB-A PLUG TO MINI USB-B LEAD
1M	LC7188	27727188	●	USB-A PLUG TO USB-A PLUG
2M	LC7189	27727189	●	USB-A PLUG TO USB-A PLUG
5M	LC7195	27727195	●	USB-A PLUG TO USB-A PLUG
2M	LC7200	27727200	●	USB-A PLUG TO USB-B PLUG
5M	LC7203	27727203	●	USB-A PLUG TO USB-B PLUG
3M	LC7210	27727210	●	USB-A PLUG TO USB-B PLUG
2M	LC7241	27727241	●	USB-A PLUG TO MICRO USB LEAD
2M	LC7243	27727243	○	USB-A PLUG TO MICRO USB LEAD

2 IN 1 1M MICRO USB-B OTG LEAD



2 in 1 Micro USB-B plug to Micro USB-B Plug or USB-A Plug. This is an OTG USB cable which enables you to transfer data such as photos

between your smartphone and tablet. Also it allows you to charge your phone through tablet.

- Fully shielded cable with moulded connectors
- Anti-twisting cable
- OTG usb, High speed charge between phones and tablet
- Data transmission between two devices
- Fast charging and expanding the scope of the equipment



NEW	1M	LC7227	27727227	USB-A/MICRO-B TO MICRO-B PLUG
------------	----	---------------	----------	-------------------------------

TYPE C



			COLOUR	
NEW	LC7805	27727805	●	1M USB-C TO USB3.0 LEAD
NEW	LC7815	27727815	●	1M USB-C TO MICRO B LEAD
NEW	LC7825	27727825	●	1M USB-C TO USB-C LEAD
NEW	LC7855	27727855	●	0.5M USB-C TO USB3.0 LEAD
NEW	LC7865	27727865	○	0.3M USB-C TO HDMI LEAD

1M LIGHTNING TO USB LEAD



- Apple MFi certification guarantee
- Nylon-braided cable

- 1 meter in length
- 8 pin lightning plug to USB A plug

			COLOUR	
NEW	IPLC1GD	27727345	●	1M LIGHTNING TO USB LEAD GOLD
NEW	IPLC1SLV	27727347	●	1M LIGHTNING TO USB LEAD SILVER
NEW	IPLC1GRAY	27727349	●	1M LIGHTNING TO USB LEAD GREY

IPHONE LEADS

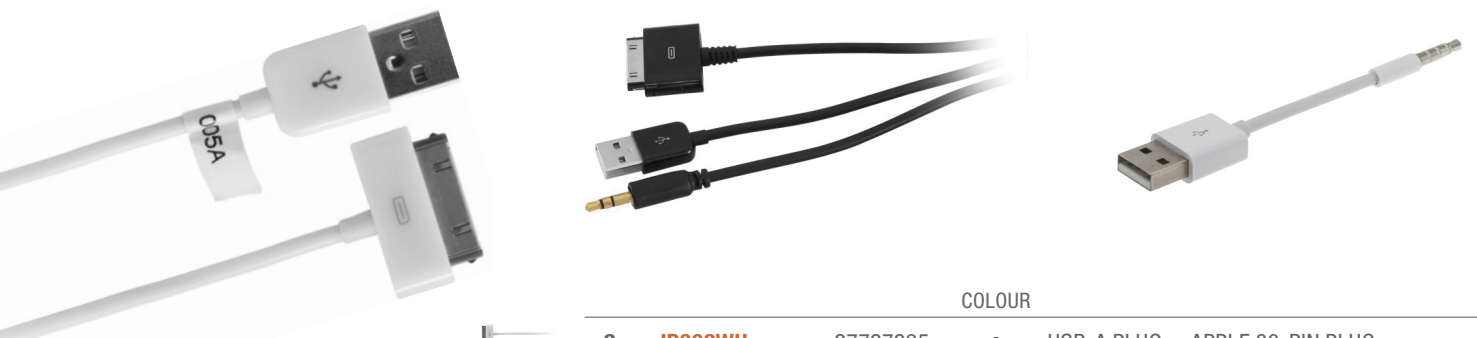

			COLOUR	
2M	IP302WH	27727295	○	USB-A PLUG TO APPLE 30-PIN PLUG
1.2M	IPDAU	27727307	●	APPLE 30-PIN PLUG TO USB-A PLUG & 3.5MM PLUG
10CM	ISHUFFLE2USB	27727301	●	IPOD SHUFFLE TO USB LEAD

USB ADAPTORS

ANDROID OTG ADAPTOR

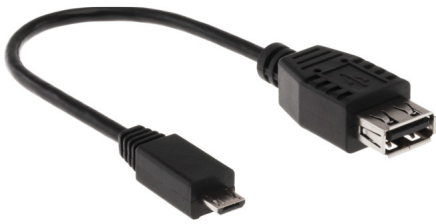

USB-OTG Cable suitable for mobile devices which feature USB-HOST or USB-OTG capability

- Connect external flash drives, keyboards, mice, and any other USB peripheral your mobile device supports!
- Micro-USB plug to USB-A Socket



LC7245 27727245

MICRO USB OTG CABLE

USB EXTENSION LEADS



COLOUR

2M	LC7190	27727190	●	USB-A PLUG TO USB-A SOCKET
5M	LC7215	27727215	●	USB-A PLUG TO USB-A SOCKET
5M	LC7218	27727218	●	ACTIVE USB EXTENSION LEAD

POWER INJECTION LEAD



If your mobile device can't power your USB device via USB-OTG, then use the LC7222 to supply it with external power!

- Perfect for USB-OTG and higher current devices!
- Built-in capacitor for protecting devices and computer from noisy external power supplies
- Simply connect your 5VDC power supply to the 2.1mm DC Socket
- Length: 30cm



30cm LC7222 27727222

USB POWER INJECTION LEAD

POWER INJECTION LEAD



Perfect for use with the USB Power Injection Lead, or simply to supply power to devices

that require 5V (using a standard 2.1mm DC socket) from a standard USB Power Pack



0.8M	NEW	LC7224	27727224	1.3MM DC PLUG	RETRACTABLE USB TO DC
0.8M		LC7225	27727225	2.1MM DC PLUG	

USB2.0 ADAPTORS



- USB cable joiner
- Useful for cable extensions



PA2310	30252310	USB-A SOCKET TO USB-A SOCKET
PA2313	30252313	USB-A SOCKET TO USB-B PLUG
PA2316	30252316	USB-A PLUG TO USB-A PLUG
PA2319	30252319	USB-A PLUG TO USB-B SOCKET
PA2322	30252322	USB-B SOCKET TO USB-B SOCKET
PA2325	30252325	USB-A SOCKET TO USB-B SOCKET
PA2346	30252346	USB A PLUG TO MICRO USB B PLUG

USB3.0 ADAPTORS



Gender Changers are ideal for connecting like-gendered cables and solving gender or connector type mismatches.

- Nickel plated connectors
- Backwards compatible with USB 2.0
- Gender changer
- Molded construction provides durability



PA2328	30252328	USB3 USB-A SOCKET TO USB-A SOCKET
PA2331	30252331	USB3 USB-A SOCKET TO USB-B PLUG
PA2334	30252334	USB3 USB-A PLUG TO USB-A PLUG
PA2337	30252337	USB3 USB-A PLUG TO USB-B SOCKET
PA2340	30252340	USB3 USB-B SOCKET TO USB-B SOCKET
PA2343	30252343	USB3 USB-A SOCKET TO USB-B SOCKET

USB ADAPTORS

DUAL-DIRECTION RIGHT-ANGLE

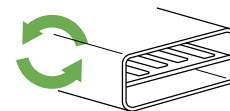
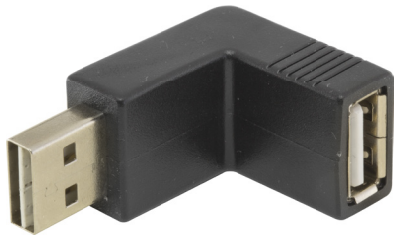

DUAL-DIRECTION PLUG

The PA2311/PA2335 right-angle adaptors feature a Dual-Direction USB-A plug which allows you to connect your adaptor in either direction! You now

only need one adaptor regardless of which way your PC or USB host devices' USB ports face!

PA2311	30252311	USB2.0	USB 2.0 RIGHT-ANGLE ADAPTOR
---------------	----------	--------	-----------------------------

PS/2 ADAPTORS



Allows you to connect your PS2 keyboard or mouse to your computer's USB Port

PA2300	30252300		PS2 SOCKET TO USB-A PLUG
PA2305	30252305		PS2 PLUG TO USB-A SOCKET

WALL PLATE INSERTS



Flexible USB3.0 Insert to suit Clipsal blank modular wall plates. Ideal for tight spaces in wall cavities, or where cable approach makes it difficult or impossible

to connect to socket. Allows cable to move and hang in its natural position without pulling out or putting unwanted pressure on the wall plate or socket.

- Gold plated connectors
- Approx 10cm lead
- Flat lead for maximum flexibility



PK4694	30634694		FLEXIBLE USB3.0-INSERT
---------------	----------	--	------------------------

WALL PLATES



SEE MORE WALLPLATES ON PAGE 72

USB 2.0 High Speed socket to socket through-connection

- Flexible cable extension on rear
- Vertical mount design
- Designed with Stainless Steel USB mounting screws



PR01237	39893390		USB WALL PLATE
----------------	----------	--	----------------

OUR CABLES PASS THE TEST

PRO2 CAT6 CABLES PASS THE FLUKE LINKWARE CABLE TEST MANAGEMENT PERFORMANCE TESTS, OUT-PERFORMING THE BIG BRANDS!

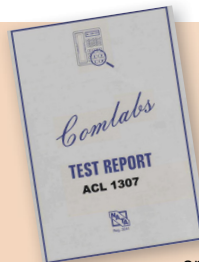

Test reports for the Pro2 range of data cables confirm that ACA and A-Tick standards are exceeded with testing for aspects like flammability and performance.

RUBBER STAMPS FLAMMABILITY TESTS

RESULTS	
The sample tested COMPLIES with Clause 5.7.2.4 of AS/NZS 5008:2001	
Individual items of this test report should not be quoted in isolation as proof of product acceptability nor applied to identify testing performance under conditions other than envisaged by the reference specification, e.g. individual fire tests to prove an overall acceptable fire hazard level.	
Sample: Cat 5e Solid Conductor Blue Strands	RESULTS:
Flaming particles shall not ignite material underlying cable shall be self extinguishing.	Complete
Time taken before flaming ceases	0 seconds
Distance from the uppermost end of the channel or affected area to the underside of the top clamp	200 mm (shall be $\ge 100\text{mm}$)
Checked: [Signature]	Approved: [Signature]
Appendix 1, Page 1	

NOISE LEVELS AND INSERTION LOSS

Test reports from the Fluke DTX1800 confirm amazing performance levels from Pro2 data cables.

Test Summary: PASS

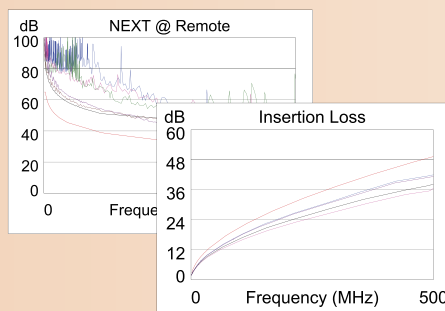

The above reading indicates just how comfortably the Pro2 CAT6A cables exceed TIA standards. The noise levels (NEXT) are far better than industry requirements, exceeding them by over 10 dB at some frequencies (that's over 3 times better!). Likewise for insertion loss (or attenuation) meaning better integrity over large cable runs.

By using higher grade PVC jackets, our cables breeze through tests. As shown above, Comlabs couldn't even ignite the our CAT5e cable, meaning testing for flammability was never going to be an issue.

OUR COMPETITORS' PERFORMANCE

They also show that some of the leading competitors have some "catching up" to do.

Test Summary: Fail

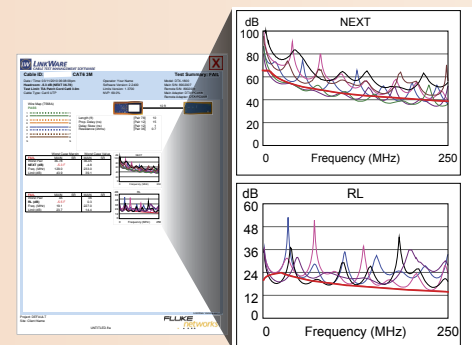

Our two leading competitors didn't fair so well with both suffering for high noise levels. One of the competitors also failed with regard to return loss—indicating poor terminations. All this poor cabling puts a strain on the network.

CAT6A PATCH SHIELDED

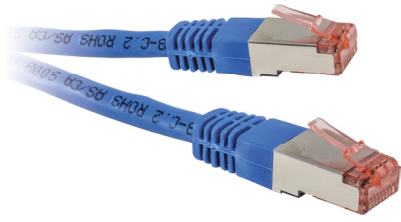

Why use shielded cable? Depending on the environment where network cable is run, it may have a large amount of EMI (Electro-Magnetic Interference). Although Cat 6A cables have improved cable twist to handle gigabit Ethernet and reject noise, this by itself is not enough for environments that have high EMI. Using a shielded Cat 6A cable will help in these high EMI installations.

Length	Status	Part Number	Product Name
0.5M	NEW	LC7520BL	27727520 BLUE CAT6A PATCH SHIELDED
1M	NEW	LC7522BL	27727522
2M	NEW	LC7524BL	27727524
3M	NEW	LC7526BL	27727526
5M	NEW	LC7528BL	27727528
10M	NEW	LC7530BL	27727530
15M	NEW	LC7532BL	27727532
20M	NEW	LC7534BL	27727534
30M	NEW	LC7536BL	27727536
40M	NEW	LC7538BL	27727538

CAT6 PATCH LEADS



CAT6 Patch Leads with molded strain relief. Features RJ45 plug-to-plug connectors and supplied fitted with flush injection moulded cable boots to prevent flaring of cables.

- Quality cable material
- Molded strain relief
- Low profile flush moulded boots
- Available Colours: Black, Blue, Green, White & Yellow



0.5M	LC7500BK 27727500	LC6600B 27726600	LC6628R NEW 27726628	LC6654G 27726654	LC6735W 27726735	LC6681Y 27726681
1M	LC7502BK 27727502	LC6603B 27726603	LC6630R NEW 27726630	LC6657G 27726657	LC6738W 27726738	LC6684Y 27726684
2M	LC7504BK 27727504	LC6606B 27726606	LC6633R 27726633	LC6660G 27726660	LC6741W 27726741	LC6687Y 27726687
3M	LC7506BK 27727506	LC6609B 27726609	LC6636R NEW 27726636	LC6663G 27726663	LC6744W 27726744	LC6690Y 27726690
5M	LC7508BK 27727508	LC6612B 27726612	LC6639R NEW 27726639	LC6666G 27726666	LC6747W 27726747	LC6693Y 27726693
10M	LC7510BK 27727510	LC6615B 27726615	LC6642R NEW 27726642	LC6669G 27726669	LC6750W 27726750	LC6696Y 27726696
15M	LC7512BK 27727512	LC6618B 27726618	LC6645R NEW 27726645	LC6672G 27726672	LC6753W 27726753	LC6699Y 27726699
20M	LC7514BK 27727514	LC6621B 27726621	LC6648R 27726648	LC6675G 27726675	LC6756W 27726756	LC6702Y 27726702
30M		LC6623B 27726623				
40M		LC6625B 27726625				

CAT5E PATCH LEADS



Moulded CAT5e patch cables provide the ultimate in reliability and can stand up to almost anything that comes their way.

- RJ-45 Plugs
- 100Mbps data rate
- Unshielded 24-gauge twisted pair
- 4-Pairs (stranded conductors)



0.5M	LC7104B 27727104	LC7138G 27727138	LC7230W 27727230	LC7148Y 27727148	
1M	LC7106B 27727106	LC7139G 27727139	LC7231W 27727231	LC7149Y 27727149	
2M	LC7112B 27727112	LC7140G 27727140	LC7232W 27727232	LC7150Y 27727150	LC7160OR 27727160
3M	LC7114B 27727114	LC7141G 27727141	LC7233W 27727233	LC7151Y 27727151	LC7161OR 27727161
5M	LC7118B 27727118	LC7142G 27727142	LC7234W 27727234	LC7152Y 27727152	
10M	LC7122B 27727122	LC7143G 27727143	LC7235W 27727235	LC7153Y 27727153	
15M	LC7125B 27727125	LC7144G 27727144	LC7236W 27727236	LC7154Y 27727154	
20M	LC7127B 27727127	LC7145G 27727145	LC7237W 27727237	LC7155Y 27727155	
30M	LC7100B 27727100				
40M	LC7102B 27727102				

CAT6A PATCH LEADS



CAT6A cables have been designed to operate up to 10Gbps speeds, 10x better than CAT6 cables

- Features RJ45 plug-to-plug connectors
- Quality cable material
- Molded strain relief
- Low profile flush moulded boots
- Colour: Blue

	0.5M	LC6500B	27726500	CAT6A PATCH LEAD
	1M	LC6502B	27726502	
	2M	LC6504B	27726504	
	3M	LC6506B	27726506	
	5M	LC6508B	27726508	
	10M	LC6512B	27726512	
	15M	LC6514B	27726514	
	20M	LC6516B	27726516	

CAT6 CROSSOVER LEAD



CAT6 Cross-over Leads with molded strain relief. Features RJ45 male-to-male connectors

- Stranded copper conductors for flexibility
- Molded strain relief & Low profile flush moulded boots
- and supplied fitted with flush injection moulded cable boots to prevent flaring of cables.
- Packaged in heat-sealed hang-sell bags.
- Colour: Black/Yellow

	10M	LC6915	27726915	CAT6 CROSSOVER LEAD
---	-----	---------------	----------	---------------------

CROSSOVER ADAPTORS

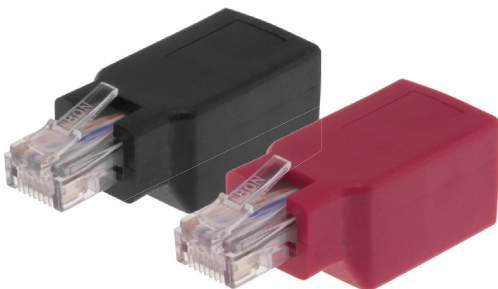

Use this adapter to connect two computers directly via Ethernet when only a patch lead is available

- Suitable for CAT5E patch leads and speeds
- RJ45 socket to RJ45 plug

	PK4040	30634040	●	CAT5e	RJ45 CAT5E CROSSOVER ADAPTOR
	PK4045	30634045	●	CAT6	RJ45 CAT6 CROSSOVER ADAPTOR

TELEPHONE LEADS

RJ12 modular telephone line cord. Extend your telephone with this modular extension lead.



- Flat telephone cable fitted on both ends with RJ12 modular telephone plugs
- Modular plug to Modular plug
- 4 Conductor (6P4C)



				COLOUR	
2M	LC0051B/BLK	43075150	●		TELEPHONE RJ12 TO RJ12 LEAD
3M	LC0056B/BLK	43075155	●		
5M	LC0091B/BLK	43075160	●		
10M	LC0095B/BLK	43075165	●		
2M	LC0051B/IVY	43075052	●		
3M	LC0056/IVY	43075054	●		
5M	LC0092/IVY	43075055	●		
10M	LC0076B/IVY	43075056	●		

TELEPHONE EXTENSION



- RJ12 connectors
- Constructed from durable plastic

15M	ERM4015B/WHT	43075060		RJ12 MODULAR EXTENSION LEAD
-----	---------------------	----------	--	-----------------------------

CURLY HAND-SET LEAD



4-conductor coiled cord fitted with 4P4C (4-Way/4-Wire) modular plugs on both ends

- Suitable for replacement / extension telephone handset

15M	CC0010/BLK	43074502		CURLY TELEPHONE HAND-SET LEAD
-----	-------------------	----------	--	-------------------------------

ADSL2+ LINE FILTER



- Works with ADSL2+
- RoHS Compliant
- Telstra listed
- 4-stage Filter minimises Cordless phone interference
- Compatible with Mode-3 connection



DSL008/2+ 43071192

ADSL2+ LINE FILTER & SPLITTER

TELEPHONE ADAPTORS



P605DMB/IVY 43072040

605 PLUG TO 2X RJ12 BLISTER



MDA66B/IVY 43075002

6P6C RJ12 DOUBLE ADAPTOR



MDA88B/IVY 43075003

8P8C RJ45 DOUBLE ADAPTOR



ILC66B/IVY 43075009

6P6C RJ12 SOCKET TO SOCKET



ILC88B/IVY 43075011

8P8C RJ45 SOCKET TO SOCKET

WALL PLATES

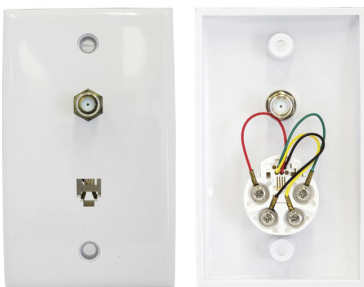

PR3870 30853870

F-TYPE WALL PLATE WITH TELEPHONE



SM166B/WHT 43075040

6P6C/RJ12 SURFACE MOUNT SOCKET

SEE MORE WALLPLATES ON PAGE 72

D-SUB LEADS



2M	LC5081	27725081	DB9 PLUG TO PLUG LEAD
2M	LC5085	27725085	DB9 PLUG TO SOCKET LEAD
5M	LC5090	27725090	
2M	LC5086	27725086	DB9 NULL MODEM CABLE
2M	LC5093	27725093	DB25 PLUG TO DB9 SOCKET

PS/2 LEADS



2M	LC6037	27726037	PS2 PLUG TO SOCKET LEAD
----	---------------	----------	-------------------------

SATA LEADS

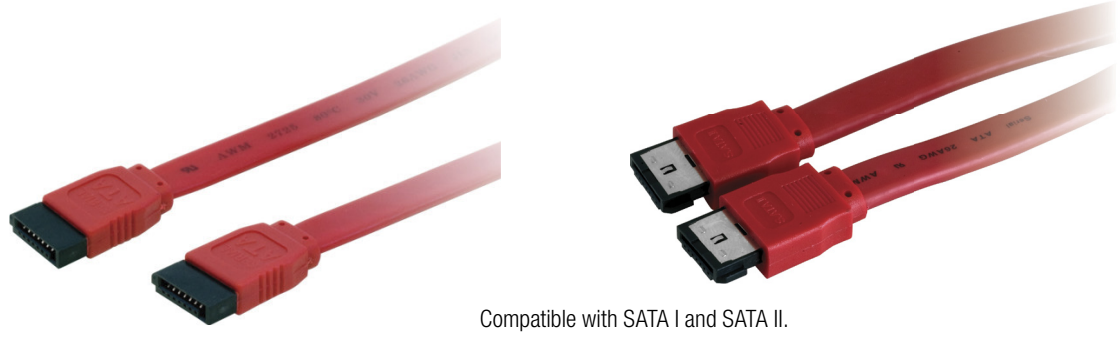

Compatible with SATA I and SATA II.

45CM	SATA45	27727420	SATA TO SATA LEAD
50CM	ESATA50	27727430	ESATA TO ESATA LEAD

COAXIAL CABLES & ACCESSORIES



- 45-48 'F' TYPE 
- 49-50 PAL 
- 50 BNC 

RF MODULATOR



The ultimate universal AV modulator. Connect any AV device via SCART*, Composite AV, or RF and

output to any television with an RF input. An ideal solution for "Cascade Surveillance" systems.

- Adjustable Channels
- Antenna In/Out
- SCART input with loop-out*

- RCA (CBVS) Inputs
- 2x Seven Segment LEDs Display
- Power supply included

*RFD2169BF only

RFD2169BF

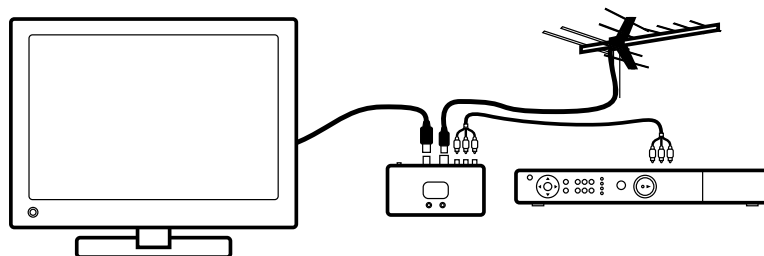

RFMX3IR

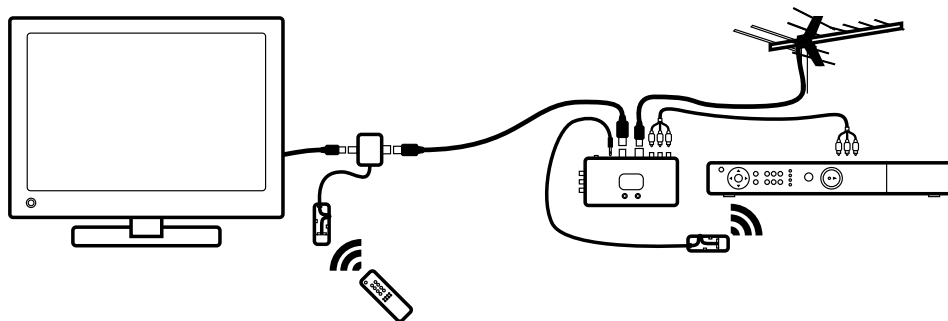

RFD2169BF	37400012		SCART OR CBVS INPUT MODULATOR
RFMX3	37400050	with gain control	3-INPUT RF MODULATOR
RFMX3IR	37400052	with IR over RF	3-INPUT RF MODULATOR
RFMX3IRST	37400054		SPARE IR TARGET FOR RFMX3IR

SURGE PROTECTOR



The SPF RF / Coaxial protector features robust gas tube technology and provides surge protection for radio frequency and coaxial cables.

- Gas tube: 90V type
- Insertion loss: 0.5dB Max. (50~470 MHz)

- Surge protection attacks time: 100ns
- Maximum surge current: 5000A per 8/20 μs

SPF 43151080

COAXIAL SURGE PROTECTOR

F-TYPE LEADS







FLYLEAD COMPRESSION



The new compression plug not only improves aesthetics for a cleaner install, but also adds strength, results in less snags when pulling











a cable from a bundle, and less crowding for improved air flow around equipment.

- 'F' type plug to 'F' type plug
- Type: RG59Q or RG6Q
- Digital ready
- Quad shield coaxial 75Ω

	0.5M	FL59Q-0.5CFF	00773010	RG59Q	'F'-TYPE PLUG TO 'F'-TYPE PLUG
	1M	FL59Q-1CFF	00773020		
	2M	FL59Q-2CFF	00773030		
	3M	FL6Q-3CFF	00773040	RG6Q	'F'-TYPE PLUG TO 'F'-TYPE PLUG
	5M	FL6Q-5CFF	00773050		
	10M	FL6Q-10CFF	00773060		
	15M	FL6Q-15CFF	00773070		

FLYLEADS



	0.3M	FL59Q-0.3FF	00771460	'F' TO 'F'	RG59	RG59QUAD 'F' TO 'F' LEAD
	1M	FL59Q-1FF	00771470			
	1.5M	FL59Q-1.5FF	00771480			
	2M	FL59Q-2FF	00771490			
	0.5M	FL59Q-0.5PF	00771330	'F' TO PAL	RG59	RG59QUAD PAL TO 'F' LEAD
	1M	FL59Q-1PF	00771340			
	1.5M	FL59Q-1.5PF	00771350			
	2M	FL59Q-2PF	00771360			
	1.5M	FL6Q-1.5PF	00771860	'F' TO PAL	RG6	RG6QUAD PAL TO 'F' LEAD
	3M	FL6Q-3PF	00771880			

PRO2 RG59 & RG6 FLY LEADS

All Pro2 Fly Leads are made from quality Quad Shielded cable so that your signals' integrity stays intact!

FLEXIBLE RG59

- RG59 is generally preferred for fly-leads due to greater flexibility over RG6.
- However, RG6 is preferred when hooking up cable or satellite TV and other broadband uses due to its performance at higher frequencies

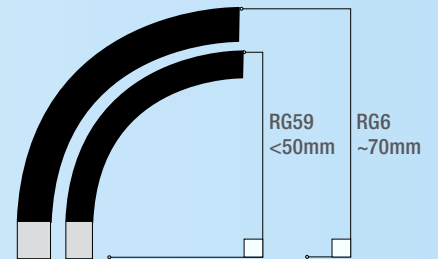

HIGH-QUALITY QUAD SHIELDING

- Quad Shielding shields signals from noise created by equipment & power cables. Digital signals are more susceptible to the negative impact of "noise" making Quad Shielding even more essential.

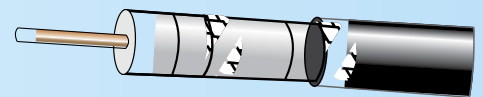

WALL PLATES



SEE MORE
WALLPLATES ON
PAGE 72

- 'F'-type socket on rear of insert



PR3850	30853850	'F' SOCKET TO SOCKET WALL PLATE
PR3860	30853860	CLIPSAL-STYLE TWIN 'F' TYPE TV WALL PLATE

WALL PLATE INSERTS



- 'F'-type socket on rear of insert



PK4601	30634601	'F'-TYPE	'F' SOCKET KEYSTONE INSERT
PK4640	30634640	'F'-TYPE	'F' SOCKET CLIPSAL-STYLE INSERT

RF MODULATOR



Distribute your AV equipment to multiple TVs through your home using RF Coaxial cable! Due to the digital switch-over, many analogue TV

channels will be available to utilize, so you can insert your AV source through this modulator feed into your existing home RF distribution network.

- Composite Input
- Composite Loop-out¹
- SCART input and loop-out²
- PAL Antenna Input/Output
- Channel Adjustment (Up/Down button)
- LED Channel Number display

¹RFD2169IR only ²RFD2169 only

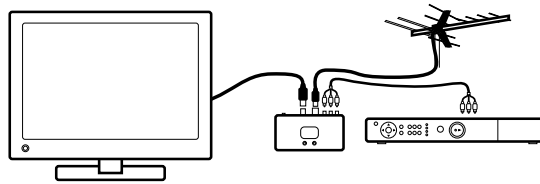

RFD2169BF

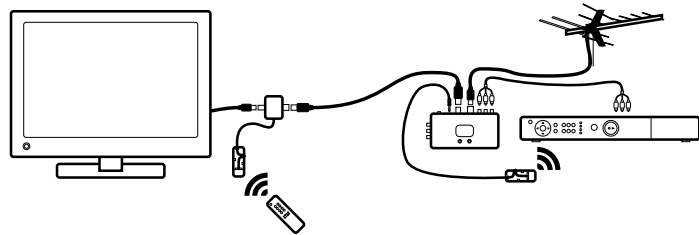

RFD2169BFIR



RFD2169	37400010	●	RF MODULATOR
RFD2169IR	37400016	●	RF MODULATOR WITH IR RETURN

ANALOGUE DEMODULATOR

Watch TV or Composite input on your Computer monitor. With built-in multimedia tuner, it presents crystal clear and flicker free pictures.

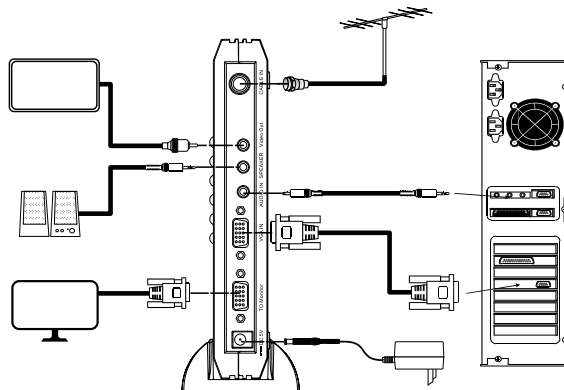













- 1920×1200, 1920×1080 Support
- PIP (Picture in Picture)
- Video Entertainment on your PC
- Easy to use remote control



ADM5	37400014		ANALOGUE DEMODULATOR COMPOSITE
-------------	----------	--	--------------------------------







FLYLEADS



	0.5M	FL59Q-0.5PP	00771070	●	RG59	RG59QUAD PAL FLYLEAD
	1M	FL59Q-1PP	00771080	●		
	1.5M	FL59Q-1.5PP	00771090	●		
	2M	FL59Q-2PP	00771100	●		
	3M	FL59Q-3PP	00771110	●		
	5M	FL59Q-5PP	00771120	●		
	10M	FL59Q-10PP	00771130	●		
	0.5M	FL59Q-0.5PPW	00771140	○	RG59	RG59QUAD PAL FLYLEAD
	1M	FL59Q-1PPW	00771150	○		
	2M	FL59Q-2PPW	00771160	○		
	3M	FL59Q-3PPW	00771170	○		
	1.5M	FL6Q-1.5PP	00771610	●	RG6	RG6QUAD PAL FLYLEAD
	1.5M	FL6Q-1.5PPW	00771675	○	RG6	RG6QUAD PAL FLYLEAD

EXTENSION LEADS



	0.3M	EL59Q-0.3PP	00771200			RG59QUAD EXTENSION LEAD
	1M	EL59Q-1PP	00771210			
	1.5M	EL59Q-1.5PP	00771220			
	2M	EL59Q-2PP	00771230			
	3M	EL59Q-3PP	00771240			
	5M	EL59Q-5PP	00771250			
	10M	EL59Q-10PP	00771260			

PAL WALL PLATE INSERTS



- 'F'-type socket on rear of insert

PK4642 30634642

PAL SOCKET TO 'F' SOCKET

BNC LEADS



0.3M **LV1495** 27471495

BNC PLUG TO BNC PLUG LEAD

2M **LV1501** 27471501

2M **LV1008** 27471008

BNC PLUG TO RCA PLUG

BNC WALL PLATE INSERTS

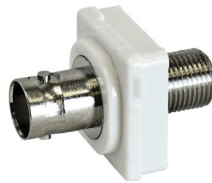

- 'F'-type socket on rear of insert

- Clipsal-style insert

PK4688 30634688

BNC TO BNC

BNC SOCKET TO BNC SOCKET

PK4690 30634690

BNC TO 'F'-TYPE

BNC SOCKET TO F-TYPE SOCKET

2-WAY TV SPLITTER



Right angle 2-Way 75Ω coaxial splitter. Commonly used in wall sockets for TV, Video or FM tuner output.

EU275P 00845260

2-WAY PAL TV ANTENNA SPLITTER

PAL WALL PLATE



SEE MORE WALLPLATES ON PAGE 72

PAL type 75Ω socket on standard electrical wall plate.

- Front: PAL 75Ω Socket

- Rear: 'F' Socket



PR3835 30853835

PAL TO F SOCKET WALL PLATE



NEW PR3888 30853888

SINGLE PAL SOCKET WALL PLATE

3-CHANNEL MIC MIXER



FRONT



REAR

The PRO2 3 Channel Microphone Mixer will mix 3 microphones with audio input, and control the volume of 3 microphones and Aux output independently. It offers simplicity and routing

flexibility in a convenient, compact, and rugged enclosure. Enhance your vocal experience with separate microphone volume levels, tone control.

- Separate audio input level control
- 4x Independent volume controls
- Passive mixer—no power required

- 3x unbalanced 6.3mm mono jacks
- & 2x RCA stereo aux input



PR01348 01454790

3-CHANNEL MICROPHONE MIXER

PRO AUDIO LEADS

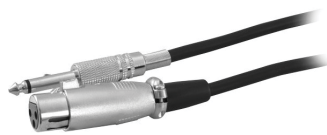

10M	LA8000	27318000	XLR EXTENSION LEAD
5M	LA8012	27318012	XLR SOCKET TO 6.3MM PLUG
6M	LA2033	27312033	MONO 6.3MM PLUG TO PLUG
2M	HLA8070	27318070	SPEAKON PLUG TO XLR PLUG
2M	HLA8073	27318073	SPEAKON PLUG TO SOCKET
2M	HLA8076	27318076	SPEAKON SOCKET TO SOCKET
2M	HLA8079	27318079	SPEAKON PLUG TO PLUG

PRO AUDIO WALL PLATE



Blank wall plate to suit a variety of XLR connectors

- Connecting screws (x2) included
- Suits narrow flange XLR connectors
- Designed to match Clipsal 2000 wall plates

**XLR connectors not included.*

PRO1240 39893395

XLR BLANK WALL PLATE

SCART LEADS



1.8M **LV5124** 27475124

21-PIN SCART PLUG TO PLUG LEAD

SCART ADAPTORS

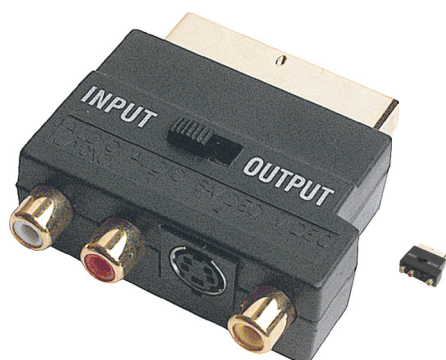

- Designed to allow regular RCA, or S-Video leads to connect to SCART socket and vice versa

PA4220 30254220

SCART PLUG TO RCA & S-VIDEO

COMPONENT SELECTORS



Increase your system's component and coaxial audio inputs!

- Instant one-touch switch and simple do-it-yourself installation
- Stylish housing



HD4DCAD	64531010	COMPONENT + STEREO + COAX	4-WAY COMPONENT VIDEO SELECTOR
----------------	----------	---------------------------	--------------------------------

4-ZONE EXTENDER



The PRO1247D allows you to extend component video, coaxial digital audio, stereo audio and IR signals to 4 different zones (expandable up to 8 with loop out function) using economical CAT5e cable.

Your source AV device (eg. DVD player) connects to the distribution hub and a 2 CAT5e cable connection is made to the receiver which is connected to your display device (eg.TV).

- Four zone Audio/Video + IR distribution
- Transmit IR signals to remotely control AV devices
- Send HD video and audio signals up to 120 metres
- Supports 480p to 1080p









PRO1247D	39894088	4-ZONE HDTV + IR OVER CAT5
PRO1247DS	39894089	SPARE RECEIVER FOR PRO1247D
PRO1247DSWP	39894090	WALL PLATE RECEIVER FOR PRO1247D

COMPONENT EXTENDERS



- Available models feature: no audio, digital audio (S/PDIF or coax), analogue stereo and IR return
- RCA connections for Video/Audio
- RJ45 socket for CAT5 transmission



		WITH	IR RETURN	
	PR01218	07350065	S/PDIF	COMPONENT WITH S/PDIF EXTENDER
	PR01276	07350095	RCA audio	COMPONENT WITH AUDIO EXTENDER
	PR01276WP	07350097	RCA audio	COMPONENT WITH STEREO WALL PLATE EXTENDER
	PR01169	39893335	S/PDIF	COMPONENT WITH S/PDIF WALL PLATE EXTENDER
	PR01170	39893337		COMPONENT WALL PLATE EXTENDER
	PR01200	39894072		• COMPONENT WITH IR WALL PLATE EXTENDER
	PR01254D	39894091	CVBS RCA audio S/PDIF	• COMPONENT WITH COMPOSITE, STEREO, S/PDIF & IR WALL PLATE EXTENDER

PREMIUM COMPONENT LEADS



GOLD
PLATED CONNECTORS

- 3x RCA Gold Plated Plugs to Plugs
- Component Video RGB (Red/Green/Blue) Interconnects
- Crystal Clear Transparent Jacket
- SPC Braid, Double Shielding

	1.5M	HLV0909	27330909	SPC COMPONENT VIDEO LEAD
	5M	HLV0915	27330915	

COMPONENT VIDEO LEADS

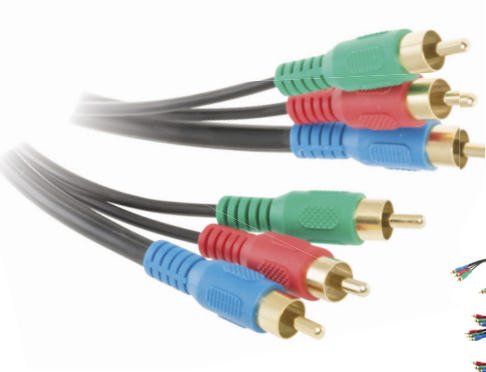

GOLD
PLATED CONNECTORS

- 3x RCA Plugs to 3x RCA Plugs (Green, Blue & Red)
- Gold Plated Connectors
- 75Ω shielded lead



0.3M	LV5186	27475186
1M	LV5188	27475188
2M	LV5190	27475190
3M	LV5192	27475192
5M	LV5194	27475194
10M	LV5196	27475196
15M	LV5198	27475198
20M	LV5200	27475200

COMPONENT VIDEO RCA LEAD

WALL PLATE



Component Video/Stereo Audio Wall Plate with RCA jacks.

- RCA connectors: YPbPr/RGB connections (Green/Blue/Red)
- Mounting hardware supplied: 2x mounting bolts, 2x short screws



PR0117 39893325

COMPONENT VIDEO + STEREO AUDIO

AV DISTRIBUTION AMP



This audio video distribution amplifier lets you split video and stereo audio output signals from a DVD, VCR, or other video sources without any signal loss.

- Send video and stereo audio signals to as many as four other TVs or VCRs
- Maintain picture quality
- Make up to four copies of your favourite camcorder tapes simultaneously



PR01047 00760656

4-WAY AV DISTRIBUTION AMP

PREMIUM S-VIDEO LEAD



GOLD
PLATED CONNECTORS

- 1x 4-Pin S-VIDEO Gold Plated Plug to Plug
- Crystal Clear Transparent Jacket
- SPC Braid, Double Shielding



1.5M	HLV0930	27330930	SPC S-VIDEO / S-VHS LEAD
3M	HLV0933	27330933	

S-VIDEO LEAD



GOLD
PLATED CONNECTORS



1.5M	LH0775	27470775	S-VIDEO & AUDIO LEAD
2M	LV0780	27470780	S-VIDEO / S-VHS LEAD
5M	LV0784	27470784	
10	LV0787	27470787	

WALL PLATE INSERTS



Keystone S-Video adaptor for many applications.

- Features an S-Video socket to IDC terminal



PK4610	30634610	S-VIDEO KEYSTONE INSERT
---------------	----------	-------------------------

PAL/NTSC CONVERTER



Convert all composite formats to PAL or NTSC (selectable via switch)

- Includes audio-through for neat installation



PNC616 64550110

PAL / NTSC DUAL CONVERTER

AV DISTRIBUTION AMP



6-Way distribution amplifier maintains good transmission quality when a Video/Audio signal is being distributed to TVs and

- Input RCA Video, RCA Audio Left & Right

other devices by ensuring the correct 1 Volt peak-to-peak signal is maintained.

- Output x 6: RCA Video, RCA Audio Left & Right (each channel)



AV486 43157982

6-WAY DISTRIBUTION AMPLIFIER

AV SELECTORS



Switch between composite video and stereo audio sources.

- Easy push-button operation



AV212 64530995

2-WAY COMPOSITE AV SELECTOR



AV313 64531002

3-WAY COMPOSITE AV SELECTOR



PR01048 64531006

4-WAY COMPOSITE AV SELECTOR

4-ZONE AV EXTENDER



Distribute composite video and stereo audio plus IR signals using economical CAT5 cable.

- Designed to be surface mounted for in-wall composite video, and stereo audio with IR return
- The system can be expanded up to 4 zones with additional PRO1235DS spare receivers

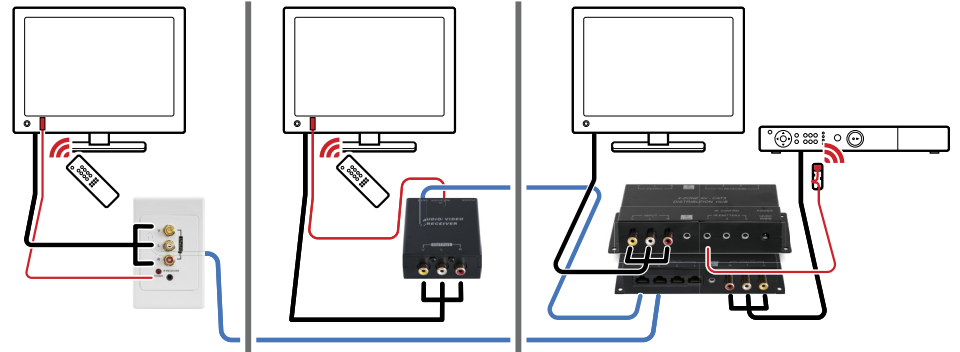

PRO1235D	39894086	Kit (Tx + Rx)	AV DISTRIBUTION OVER CAT5
PRO1235DS	39894087	Spare receiver	SPARE RECEIVER FOR PRO1235D
PRO1235DSWP	39894085	Wallplate receiver	WALL PLATE RECEIVER FOR PRO1235D

AV EXTENDERS



		IR Return	Range	
	PRO1221	07350080	300m	COMPOSITE AV CAT5 EXTENDER
	PRO1211	07350120	300m	COMPOSITE AV CAT5 EXTENDER
	PRO1177	39893331	100m	COMPOSITE AV CAT5 WALL PLATE EXTENDER
	PRO1199	39894067	100m	ACTIVE COMPOSITE STEREO + IR KIT

AV LEADS

GOLD
PLATED CONNECTORS



- 3x RCA Plugs to 3x RCA Plugs (Yellow, Red & White)

- Gold plated connectors

0.3M	LV1002	27471002
1M	LV1004	27471004
2M	LV1005	27471005
3M	LV1006	27471006
5M	LV1110	27471110
10M	LV1115	27471115
15M	LV1117	27471117
20M	LV1120	27471120

COMPOSITE VIDEO & STEREO LEAD

AV TO RCA LEAD



- 4-Contact 3.5mm Plug to 3x RCA Plugs
- Ideal for connecting your video camera to your TV, PVR or amplifier.

- Nickel plated connectors
- Length: 2m

2M **LA1077** 27311077

4-CONTACT 3.5MM PLUG TO 3X RCA PLUGS

4-WAY RCA LEAD



- 4x RCA Plugs to 4x RCA Plugs
- Nickel plated connectors

- Black molding
- Length: 2m

2M **LA3049** 27313049

4X RCA PLUG LEAD

WALL PLATES

GOLD
PLATED CONNECTORS



SEE MORE
WALLPLATES ON
PAGE 72

Clipsal-style composite video & audio wall plate

- 3x gold plated RCA connections



PR01121 39893321

COMPOSITE AV WALL PLATE

PREMIUM STEREO LEADS

GOLD
PLATED CONNECTORS



1.5M HLA8050 27318050

SPC RCA STEREO AUDIO LEAD

5M LH0328 27330328

STEREO RCA LEAD WITH OFC

**RIGHT ANGLE RCA
STEREO LEAD**

GOLD
PLATED CONNECTORS



- Gold-plated RCA plug
- AWG26, OD=3.0/3.0mm
- PVC jacket



NEW 2M **LA3041** 27313041

2 X RCA PLUG TO 2 X RCA PLUG

RCA AUDIO LEADS



GOLD
PLATED CONNECTORS



GOLD-PLATED

0.3M	LA3013	27313013	•	2x RCA STEREO LEADS
1M	LA3015	27313015	•	
2M	LA3017	27313017		
3M	LA3020	27313020	•	
5M	LA3033	27313033	•	
10M	LA3035	27313035	•	
15M	LA3037	27313037	•	
20M	LA3038	27313038	•	
0.3M	LA3061	27313061	•	STEREO RCA EXTENSION LEAD
1M	LA3063	27313063	•	
0.3M	LA1050	27311050	•	3.5MM PLUG TO 2x RCA LEAD
1M	LA1051	27311051	•	
2M	LA1052	27311052	•	
3M	LA1053	27311053	•	
5M	LA1055	27311055	•	
10M	LA1057	27311057	•	
15M	LA1059	27311059	•	
20M	LA1061	27311061	•	
0.3M	LA1048	27311048	•	3.5MM SOCKET TO 2X RCA
0.3M	LA3082	27313082	•	RCA TO 2x RCA SOCKET LEAD
NEW 5M	LA3086	27313086	•	
2M	LA3097	27313097		RCA TO 2x RCA PLUG LEAD
5M	LA3098	27313098		

MONO RCA LEADS



GOLD
PLATED CONNECTORS



2M	LV5163	27475163	RCA PLUG TO PLUG LEAD
3M	LV5166	27475166	
5M	LV5167	27475167	
10M	LV5168	27475168	
2M	LA1081	27311081	MONO 3.5MM PLUG TO RCA SOCKET PLUG

WALL PLATE INSERTS



GOLD
PLATED CONNECTORS



		COLOUR	GOLD-PLATED	
PK4644	30634644	●	●	RCA SOCKET TO 'F' SOCKET
PK4646	30634646	●	●	
PK4648	30634648	●	●	
PK4650	30634650	●	●	
PK4652	30634652	○	●	
PK4654	30634654	●	●	
PK4662	30634662	●		RCA SOCKET TO SOCKET
PK4664	30634664	●		
PK4666	30634666	●		
PK4668	30634668	●		
PK4670	30634670	○		
PK4672	30634672	●		
PK4674	30634674	●		RCA SOCKET TO SOLDER
PK4678	30634678	●		
PK4684	30634684	●		

GROUND-LOOP ISOLATOR



The PRO1059 will solve the problem of ground loop issues and easily connects in any audio system!

- Frequency range: 10~20,000 Hz
- Insertion loss: 1dB @ 1kHz
- Connection: RCA Sockets to RCA Plugs
- Channel separation: 45dB @ 1kHz minimum

PRO1059 40451285

RCA GROUND LOOP ISOLATOR

RCA PUSH-PIN ADAPTOR

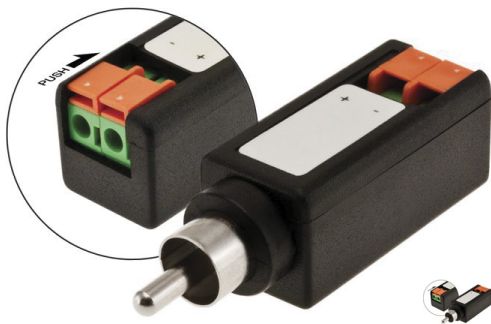

- Saves time and the trouble of soldering your connections
- Sold individually—single plug only
- Use the press terminals to have a firm and reliable connection in seconds!

PD2920 30362920

RCA PLUG PRESS TERMINATION

PREMIUM STEREO LEAD



- 3.5m stereo plug to plug
- Gold plated connectors
- Assembled pearl chrome-plated metal shell
- Length: 2m

2M HLA8080 27318080

PREMIUM STEREO 3.5MM PLUG LEAD

CURLY STEREO LEAD



NEW 1M **LA1092** 27311092

SLIM CURLY 3.5MM PLUG TO PLUG

STEREO LEADS



- Gold plated 3.5mm stereo plug
- Black molding



2M	LA1033	27311033	STEREO 3.5MM PLUG TO PLUG
3M	LA1035	27311035	
5M	LA1039	27311039	
10M	LA1042	27311042	
15M	LA1044	27311044	
20M	LA1045	27311045	
2M	LA1063	27311063	STEREO 3.5MM PLUG TO SOCKET / EXTENSION
5M	LA1065	27311065	

SLIM STEREO LEADS



0.3M	LA1030	27311030	SLIM STEREO 3.5MM PLUG TO PLUG
1M	LA1031	27311031	

STEREO HEADPHONE HUB



- Connect up to 5 head phones with your iPod or any other portable media device
- 6x 3.5mm stereo sockets
- 3.5mm stereo sockets, compatible with any iPod, iPhone, MP3 player, DVD player etc.
- Supplied with 15cm 3.5mm plug to plug lead

PA1063	30251063	6-WAY STEREO 3.5MM HEADPHONE HUB
---------------	----------	----------------------------------

TRRS TO STEREO & MIC ADAPTOR



- Can be used with IOS devices that use a 4 position 3.5mmjack, such as iPhone, iPod and iPad devices
- TRRS Plug to 2 x TRS sockets Stereo/Mic adapter
- High Quality Silver Plated Connectors

NEW PA1078WH	30251078	4POLE PLUG TO 2X 3.5MM SOCKETS
NEW PA1080BL	30251080	

DISTRIBUTION, WALLPLATES & MISCELLANEOUS



- 67 WIRELESS AUDIO
- 68-71 AMPS / MULTIROOM / SPEAKER
- 72-75 WALL PLATES
- 76-79 IR DISTRIBUTION
- 80-81 IPHONE / IPAD
- 82 ACCESSORIES & MISC



BLUETOOTH RECEIVER



Lose the wires without compromising audio quality or having to upgrade your audio system!

- Incorporates the Apt-X codec for exceptionally high CD quality wireless performance
- Dual simultaneous digital & analogue output
- S/PDIF Optical output
- 3.5mm analogue stereo output
- Low 70ms latency
- Low SNR: >100dB
- High level output: 2Vrms



BMR3X 39894385

BLUETOOTH MUSIC RECEIVER

BLUETOOTH SPEAKER AMP



Use the PRO1351 to power in-ceiling speakers with the audio from any Bluetooth enabled device

- Bluetooth wireless audio receiver built-in
- Switch between Bluetooth or 3.5mm (line) inputs
- Compact design
- Volume control
- Suitable for 4Ω, 6Ω and 8Ω speakers
- 15W RMS per channel @ 4Ω
- Includes Speaker Protection circuit



PRO1351 01458312

BLUETOOTH AUDIO POWER AMP

PRO1351WP 01458314

BLUETOOTH WALL PLATE AMP

STEREO LINE PREAMP



This audio pre-amp is great for audio distribution systems where sources may have different output levels. Adjust the pre-amp gain so

your source is matched with the others before entering your distribution or zone amps!

- Frequency Response: 20Hz to 20kHz
- Gain Control: 0-15dB
- S/N Ratio: >85 dB

PRO1327 60850430

STEREO AUDIO LINE PREAMP

PHONO PREAMP



- Ultra compact design
- Use either 9V Battery or 9V / 100mA Power supply (not included)
- Simply plug and play
- Current consumption: 1mA (average)
- Amplification: 34dB

In order to connect your turntable to the line-level inputs most amplifiers have (Aux, Tape,

Line, Video, CD, etc.), you need to first pass the signal through an external preamp.

PA005 60850410

INLINE PHONO PREAMP

3-INPUT SPEAKER AMP

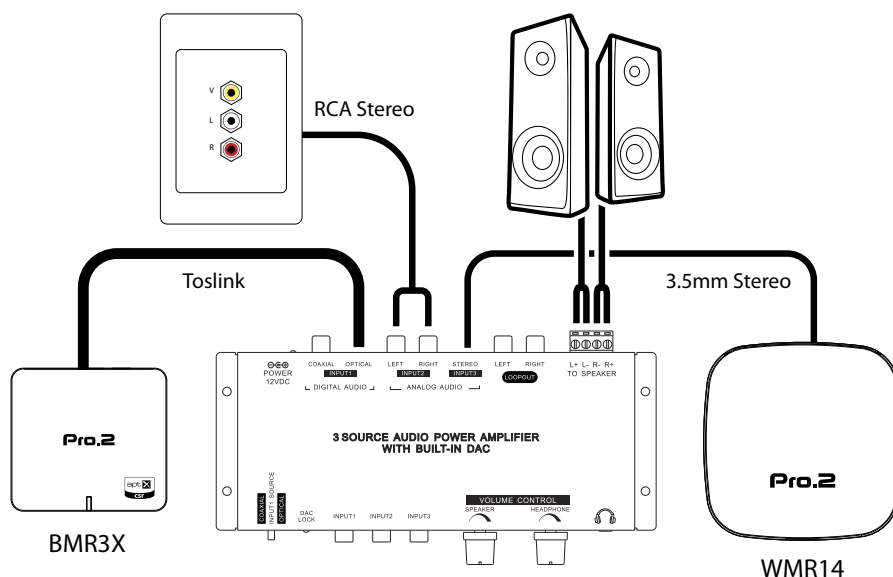

3-source Audio Power Amplifier with built-in DAC

- Output power: 15W RMS per channel
- Amplifier Type: Stereo D-Class
- Digital Input Type: Coaxial & Optical
- Frequency Response: 32 – 192kHz sample rate



PR01299 01458292

3-SOURCE AMP WITH BUILT-IN DAC

HEADPHONE AMP



Perfect for headphone displays in stores or create your own Silent Cinema room at home! Connect up to four sets of headphones, each with individual volume controls.



PR01340 01458306

4-way

4-WAY HEADPHONE AMPLIFIER

PR01343 01458308

1-way

HEADPHONE AMPLIFIER

4-ZONE SPEAKER AMP WITH DAC



FRONT



REAR

The PRO1323 is a quick and easy way of adding audio in up to four rooms

- 4-zone speaker amplifier
- 15W per channel @ 4Ω
- Digital (Optical / Coaxial selectable), RCA Stereo, 3.5mm Stereo & Dynamic Microphone inputs
- Stereo loop-out for connecting multiple units
- Individual volume controls for each zone
- Headphone output for monitoring (with volume control)



PRO1323 01458298

4-ZONE AUDIO POWER AMPLIFIER WITH DAC

4-ZONE SPEAKER AMP



FRONT



REAR

- 4-zone speaker amplifier
- Analogue stereo input
- 15W per channel @ 4Ω
- Stereo loop-out for connecting multiple units
- Individual volume controls for each zone
- Headphone output for monitoring (with volume control)

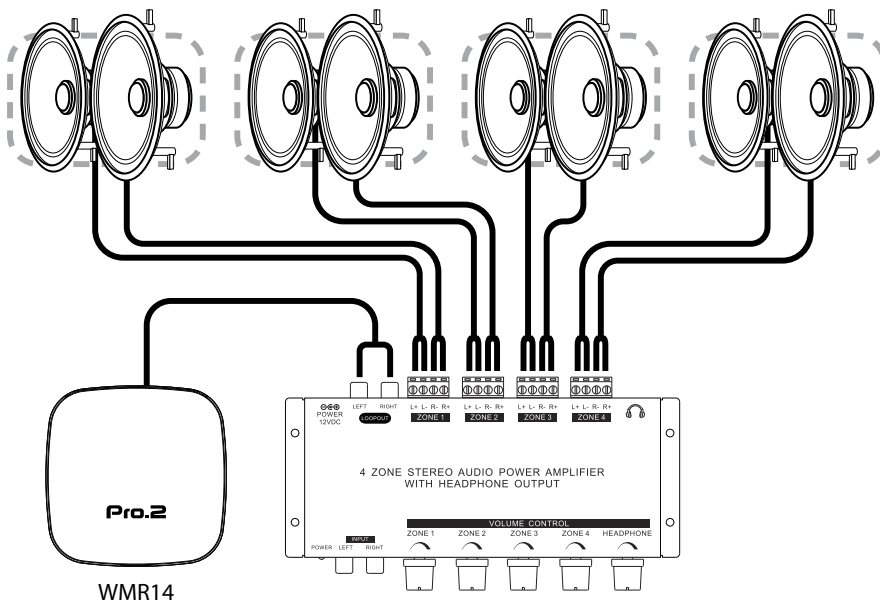

PRO1300 01458295

4-ZONE STEREO POWER AMPLIFIER

SPEAKER AMP WITH REMOTE



Provides manual or remote volume control

- 15Wrms into 4Ω speakers
- Amplifier Type: Stereo Class-D
- Provides volume level indicator
- Provides 3 IR path remote control

PR01358 01454132

STEREO AUDIO POWER AMPLIFIER WITH IR REMOTE CONTROLLED VOLUME

SPEAKER AMP



Use the PR01328 to power in-ceiling speakers with the audio output from any source device such as computers, DVD players, TVs and even Microphones.

- Small size and compact
- Also suitable for wall-mounting
- Works with 4Ω, 6Ω and 8Ω speakers
- Speaker screw terminals handle wire sizes from 24 to 12 gauge
- 15W RMS per channel @ 4Ω

In-Wall / In-Ceiling Speakers (not included)



PR01328 01458301

STEREO AUDIO POWER AMPLIFIER

PR01328WP 01458303

AUDIO AMPLIFIER WALL PLATE

PR01328K 01458307

STEREO AUDIO POWER AMPLIFIER WITH SPEAKER VOLUME CONTROL

SPEAKER SELECTORS

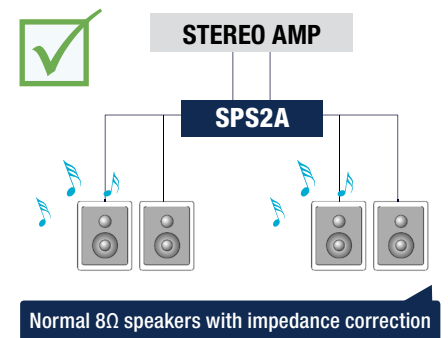
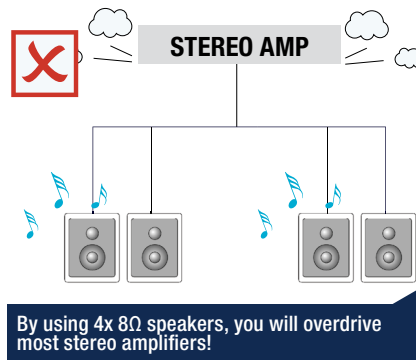

	SPS4	39894110	4-way	4-WAY SPEAKER SELECTOR
	SPS6	39894120	6-way	6-WAY SPEAKER SELECTOR
	SPS2A	39894125	2-way	2-WAY SPEAKER SELECTOR/SWITCH WITH VOLUME CONTROL
	PRO1022	39894142	2-way	2-WAY WALL PLATE SPEAKER SELECTOR
	PRO1001	39894123	2-way	2-WAY STEREO SPEAKER SWITCH (A/B/A+B)

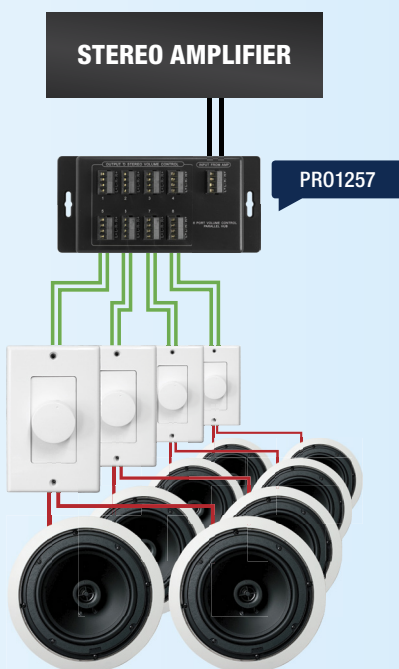

MULTI-SPEAKER INSTALLATION CONSIDERATIONS

When installing multiple speakers to an amplifier output, it's important to consider the following:

- To ensure optimal operation of your amplifier or receiver, you must show it a load that it can handle safely. This generally requires the use of impedance matching devices when connecting multiple speaker pairs
- Calculate the impedance matching settings
- (refer to the table below as a guide)
- Total speaker wattage must be within the amplifier's power output capacity
- Always double check settings and test impedance is correct before connecting to your amplifier

IMPEDANCE SEEN BY AMPLIFIER	SPEAKER IMPEDANCES			SPEAKER SELECTOR OR VOLUME CONTROLLER SETTING
	2Ω # PAIRS	4Ω # PAIRS	8Ω # PAIRS	
4Ω	2	1	-	1x
	4	2	1	2x
	8	4	2	4x
	16	8	4	8x
8Ω	4	2	1	1x
	8	4	2	2x
	16	8	4	4x
	32	16	8	8x
16Ω	8	4	2	1x
	16	8	4	2x
	32	16	8	4x
	64	32	16	8x

SPEAKER WALL PLATES

DISTRIBUTION HUB

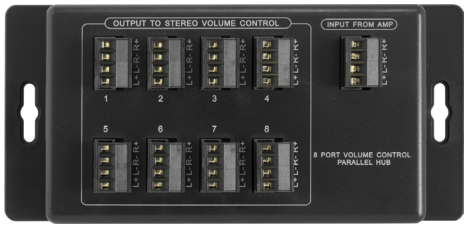

8-way speaker hub for use with parallel volume controls

- Enables volume control in up to 8 rooms
- Light weight
- Screw terminals handle wire sizes from 24 to 12 gauge
- Wall mountable
- Small size and compact
- Requires the use of impedance-matching volume controls



PRO1257 39894138

8-WAY SPEAKER HUB

VOLUME CONTROLLER



			TYPE	IR	
PRO1191	39894062	6-step	4 / 6 / 8Ω		60W VOLUME ATTENUATOR
PRO1163P	39894063	12-step	1x / 2x / 4x / 8x		100W VOLUME ATTENUATOR
PRO1161	39894060	12-step	1x / 2x / 4x / 8x	•	100W VOLUME WITH IR

SPEAKER TERMINALS



PRO1030	39893110	2-way		CLIPSAL-STYLE SPEAKER TERMINAL WALL PLATE
PRO1032	39893115	4-way		
PRO1034	39893117	6-way		
PRO1044	39893120	8-way		
PRO1143	39893123	12-way		
PRO1144	39893122	16-way		DECORA-STYLE SPEAKER TERMINAL WALL PLATE
PRO1144A	39893124	14-way + 1x RCA		

WALL PLATE INSERTS



▪ Speaker terminal for clipsal insert

▪ Gold plated terminals

PK4658	30634658	●	BLACK SPEAKER TERMINAL CLIPSAL INSERT
PK4660	30634660	●	RED SPEAKER TERMINAL CLIPSAL INSERT

CLIPSAL-STYLE WALL PLATES

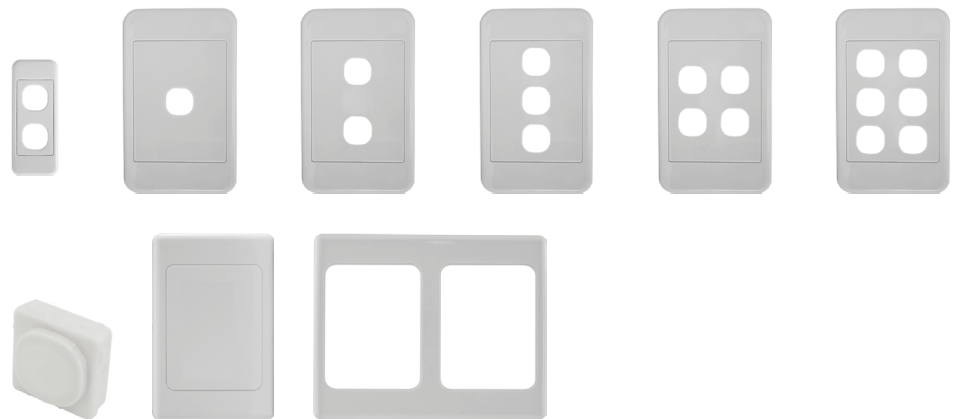

	PK4576	30634576	1-gang	1-GANG ARCHITRAVE PLATE
	PK4578	30634578	2-gang	2-GANG ARCHITRAVE PLATE
	PK4580	30634580	1-gang	1-GANG WALL PLATE
	PK4582	30634582	2-gang	2-GANG WALL PLATE
	PK4584	30634584	3-gang	3-GANG WALL PLATE
	PK4586	30634586	4-gang	4-GANG WALL PLATE
	PK4588	30634588	6-gang	6-GANG WALL PLATE
	PK4656	30634656		BLANK INSERT TO SUIT
	PR01024B	11953401		BLANK WALL PLATE
	PR01153	39893380		2-PLATE WALL PLATE COVER

KEYSTONE WALL PLATES



[Video online](#)

▪ Fits standard electrical switch plate installation hardware and screw centres.

▪ Perfect for easy flush installation on Gyrock or fibro cavity walls.

	PK4570	30634570	3-gang	3-GANG KEYSTONE WALL PLATE
	PK4575	30634575	4-gang	4-GANG KEYSTONE WALL PLATE

BLANK INSERT



Decora-style empty insert wall plate
 ■ 2x Short screws included

PRO1024 39893327

BLANK WALL PLATE WITH CUT-OUT

BRUSH WALL PLATES



PRO1272 39893365 ○ WHITE BRUSH WALL PLATE

PRO1272B 39893366 ● BLACK BRUSH WALL PLATE

PRO1272D 39893367 ○ DECORA BRUSH WALL PLATE

PRO1273 39893410 ○ DUAL BRUSH WALL PLATE

WHITE BRUSH WALL PLATE

BLACK BRUSH WALL PLATE

DECORA BRUSH WALL PLATE

DUAL BRUSH WALL PLATE

BULL-NOSE WALL PLATES



These unique wall plates allow cables to enter the wall cavity space without the need for interconnect wall plates in between.

■ Ideal for instances where you have pre-made leads directly out of the wall cavity.

■ Bristle brush design prevents dust and bugs from entering from the wall cavity.



BNWP01 11953405 ○ WHITE BULL-NOSE WALL PLATE

BNWP01B 11953406 ● BLACK BULL-NOSE WALL PLATE

LPBNWP 11953407 ○ WHITE LOW PROFILE BULL-NOSE

REVBWP 11953408 ○ WHITE REVERSE BULL-NOSE WALL

WHITE BULL-NOSE WALL PLATE

BLACK BULL-NOSE WALL PLATE

WHITE LOW PROFILE BULL-NOSE

WHITE REVERSE BULL-NOSE WALL

MODULAR WALL PLATE INSERTS

At Pro2, we understand that each job is different and each setup is unique. So that's why we created the MWI13 modular wall plate range. Need 2 HDMI sockets and a Foxtel point on the wall? No problem, just pick your parts and assemble your own. Need to replace an old USB2 port with USB3? Just swap out the old one and replace it with the new without touching any other connector. With our modular design you can simply mix and match up to 3 modules to suit your needs. They snap on tightly and securely giving a perfect finish, each time.

STEP 1

Grab the MW13FR blank frame

STEP 2

Choose up to 3 modules to make the exact wall plate you need

EASY!

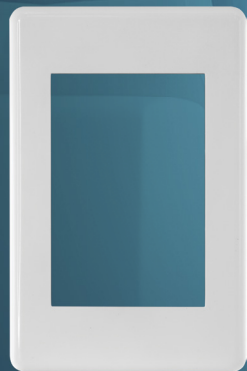

FRAME WALL PLATE
MW13FR | 30634800

- Suits all inserts
- Fits 3 inserts or 1 brush module



BRUSH MODULE
MW13BR | 30634890



Mix and match 3 modules and create your



DVI MODULE
1x DVI
MW13DVI | 30634875

RCA			PAL	RGB	
VIDEO MODULE 1x RCA MW13RCA1 30634805	STEREO MODULE 2x RCA MW13RCA2 30634810	AV MODULE 3x RCA MW13RCA3 30634815	PAL TO 'F' MODULE 1x PAL MW13PF 30634825	COMPONENT MODULE 3x COMPONENT RCA MW13RGB 30634820	
'F' FOXTEL APPROVED		TOSLINK	3.5MM	BANANA	
'F' MODULE 1x 'F' MW13FF 30634830	'F' MODULE X2 2x 'F' MW13FF2 30634832	TOSLINK MODULE 1x TOSLINK MW13TOS 30634835	AUDIO MODULE 1x 3.5MM MW13A35 30634840	SPEAKER MODULE 2x BANANA MW13SPK 30634845	
BNC	USB			HDMI	
BNC MODULE 1x BNC MW13BNC 30634880	USB 2.0 MODULE 1x USB 2.0 MW13USB2 30634865	USB 3.0 MODULE 1x USB 3.0 MW13USB3 30634867	USB B MODULE 1x USB B MW13USBB 30634869	HDMI MODULE 1x HDMI MW13HDMI 30634870	
VGA	CAT5E / CAT6			BLANK	
VGA MODULE 1x DB15 MW13VGA 30634860	JOINER MODULE 1x CAT5E MW13C5J 30634855	MECH MODULE 1x CAT6 MW13C6M 30634850	BLANK MODULE FOR BLANK SPACES MW13BL 30634885	KEYSTONE MODULE FITS KEYSTONE INSERTS MW13KS 30634848	

IR OVER COAXIAL



This kit allows IR signals to be inserted onto a coax cable in one location and extracted from coax on another location.

- Creates an IR system with existing wiring
- Powers up to 4x IR receivers
- with one power supply
- Quick and easy installation

BASIC

MAIN ROOM

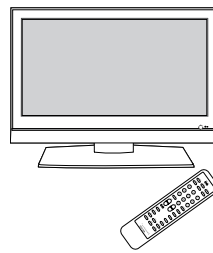

ROOM 1

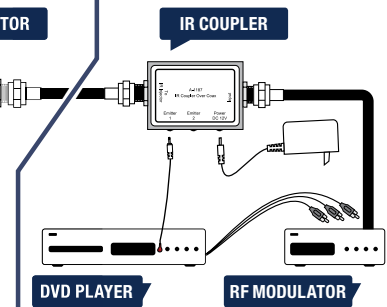

ADVANCED

ROOM 1

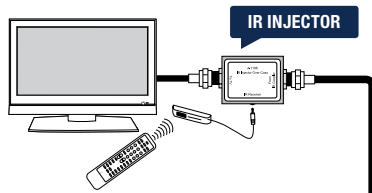

ROOM 2

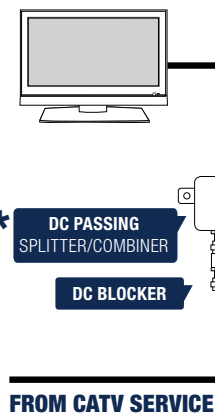
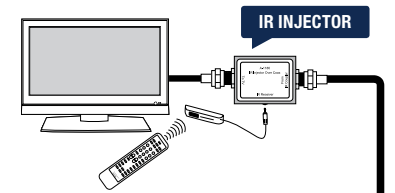

MAIN ROOM

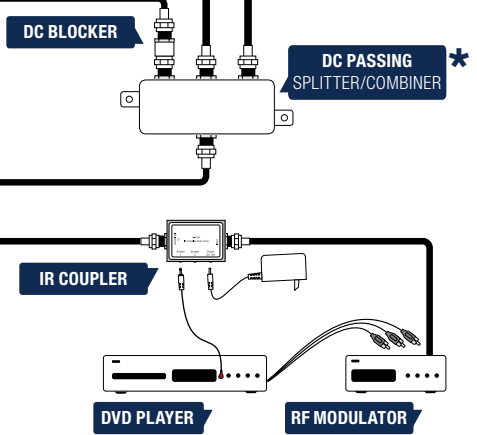

* DC and IR Passing Splitter/Combiners are required for this setup. Use of a Non-DC Passing Splitter will stop the IR System from working as any voltage leak from the TV affects the IR signal; DC blockers such as Resi-linx RLACC130 are perfect for this. We also recommend the use of **Channel Plus** Splitter/combiners (models 2512 & 2514 have been tested and confirmed to work with this system). Confirm your Splitter/combiners support DC and IR passing before installation!



PRO1188A	37168736	Kit	IR OVER COAX SYSTEM
PRO1188AS	37168737	Spare receiver	SPARE RECEIVER FOR PRO1188A

COMPACT IR REPEATER KIT



Hide your AV equipment in a cupboard or rack without losing the ability to control them with their Remote Controls

- Quick and simple installation
- Four amplified emitter output connections
- Convenient IR confirmation LED
- Compact size for mounting near equipment
- IR receiver and emitters supplied
- Compatible with Foxtel iQ2/iQ3

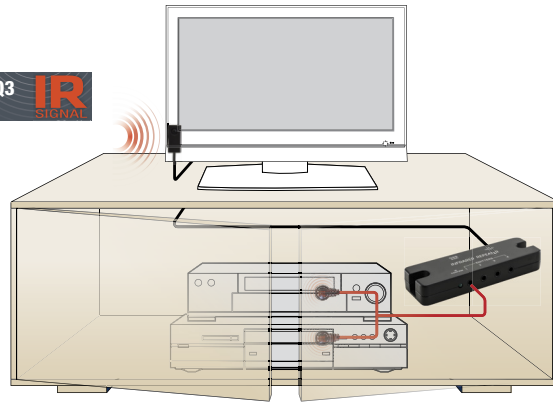

PRO1326 37168700

COMPACT IR REPEATER KIT

IR OVER RF EXTENDER



The Pro2 IRE12 transmitter takes the standard IR signal from your existing remote controls and

converts it to the more powerful and reliable RF frequency which can pass through walls and objects!

- Maximum range: 50m line-of-sight
- 433.92MHz operating frequency
- Compatible with Foxtel iQ2/iQ3

MAIN ROOM

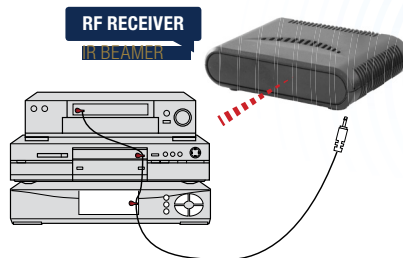

ROOM 1



IRE12 37169700

Kit

IR REMOTE CONTROL EXTENDER

IRE12SPT 37169702

Spare IR transmitter

SPARE IR TRANSMITTER FOR IRE12

IR REPEATER KIT



Connects IR receivers, power supply and emitters together to interface the IR system to the audio/ video components.

- Six emitter output connections
- Convenient IR confirmation LED
- Status power receptacle with LED indicator
- Compact size for mounting near audio equipment



PR01183 37168730

IR REPEATER KIT

IR RECEIVERS



IR repeater wall plate kit connects the IR connecting block, IR receiver, IR emitter,

and power supply together to interface the IR system to Audio/Video components.

- Three emitter output connections
- Convenient IR confirmation LED
- Status power connector with LED indicator



PR01255 37168731

IR REPEATER WALL PLATE KIT

PR01140 37168738

WALL PLATE IR RECEIVER



PR01292 37168805

BRASS IR RECEIVER TUBE



PR01178A 37168734

SURFACE MOUNT IR RECEIVER

IR EMITTERS & TARGETS



Control devices from the output on your IR distribution module.

- For use with Connecting Blocks and Home Automation controllers
- Round shape, with elegant compact size
- Infra-red diode is built-in transparent housing
- 10 foot cable length



PR01142 37168732

DUAL IR EMITTER

PR01141 37168733

SINGLE IR EMITTER

PR01178A 37168734

DUAL IR TARGET

PR01330 37168702

TUBE IR TARGET FOR PR01326

IR DISTRIBUTION HUB

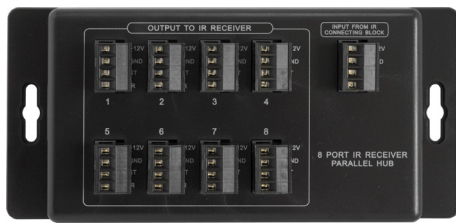

- Distribute infrared signal from an IR repeater (eg PRO1183) to up to eight receivers

- Large detachable terminal block (supplied) for quick and easy installation in structured wiring cabinet



PRO1256 39894134

8-PORT IR RECEIVER PARALLEL

IR LEAD



6m **PRO1297** 37168815

IR EXTENSION LEAD

IR RECEIVER ADAPTOR



- Easy to install
- Easily connect IR receivers to UTP cable

- Spring-clamp terminal block
- Wire range: 20-26 AWG

PRO1294B 37168807

IR RECEIVER ADAPTOR

IR KEYSTONE ADAPTER

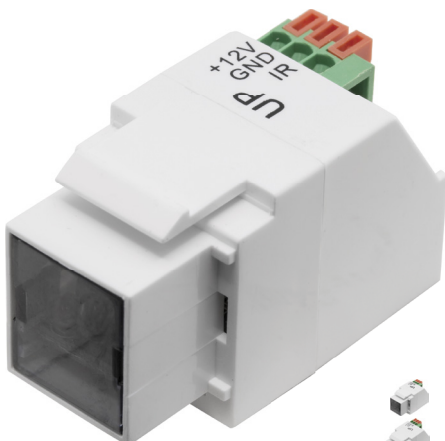

NEW **PK4912** 30634912

DUAL BAND KEYSTONE IR RECEIVER

NEW **PK4914** 30634914

IR EMITTER KEYSTONE ADAPTOR

NEW **PK4916** 30634916

IR RECEIVER KEYSTONE ADAPTOR

IPHONE 5 ADAPTOR



- Supports sync and charging and audio output
- This adaptor lets you connect devices with a Lightning connector to many of your 30-pin accessories
- Plug this adapter into iPhone 5 via 8-pin port, then plug your 30-pin accessories into this adapter via the 30-pin port

PA4390	30254390	○	8-PIN TO 30-PIN ADAPTOR WHITE
---------------	----------	---	-------------------------------

IPHONE 5/6 FLASH DRIVE



Works as an external memory expansion for iPhones / iPads / iPods with a Lightning connector

- Compatible with Apple devices with Lightning plug
- USB Plug for connecting and transferring files with a PC
- Easily transfer data without jail-breaking or connecting to a network

	IFLASHMS	08882860	Micro SD	IFLASH DRIVE WITH MICRO SD CARD READER
	IFLASH32	08882862	32GB	IFLASH DRIVE WITH 32GB MEMORY
	IFLASH64	08882864	64GB	IFLASH DRIVE WITH 64GB MEMORY

APPLE 30-PIN EXTENSION



Perfect for connecting your iPhone, iPad or iPod to any accessory with a dock connector without having to remove the case or inconveniently positioned

- 30-pin socket to 30-pin plug
- Extend the reach between your accessories and your iPhone/iPod
- Length: 1.2m
- Only supports sync & charge

1.2M	IPEX12	27727302	EXTENSION CABLE FOR IPOD
------	---------------	----------	--------------------------

APPLE 30-PIN TO LIGHTNING



Connects your existing Apple 30-pin cable to Apple's new Lightning connector, for syncing and charging

- Charges and syncs only
- Colour: White
- Length: 15cm

	15CM	LC7360	27727360	IPHONE 5 LIGHTNING TO 30-PIN
--	------	---------------	----------	------------------------------

IPHONE 5/6/7 CAR CHARGER



Features the Apple Lightning connector that provides hassle free and compact connection to your iPhone 5/6 or other current generation iDevices.

- Input: DC12-24V
- Output: Max. DC5.0V/1000mA
- Cable length: 1 metre
- Charger size: 8.7 x Ø3.5 cm

IPHCAR	33774490		CAR CHARGER FOR IPHONE 5
---------------	----------	--	--------------------------

IPHONE DOCKS



UNIDOCKW	01616010	○	WHITE UNIVERSAL IPHONE AUDIO+CHARGE
UNIDOCKB	01616012	●	BLACK UNIVERSAL IPHONE AUDIO+CHARGE
5GDOCKB	01616020	●	BLACK IPHONE 5 CHARGING DOCK

IPHONE6/7 CHARGING DOCK WITH AUDIO OUT



Listen to music and charge your iPhone at the same time

- 3.5mm out to connect headphones speakers and more

7LDOCKG	01616022	○	WHITE UNIVERSAL IPHONE AUDIO+CHARGE
----------------	----------	---	-------------------------------------

LIGHTNING TO 3.5MM ADAPTOR



Are you very excited about your new iPhone 7/7+? Of course, but what if you don't want to upgrade your wired headphone just yet?

- This Lightning to 3.5mm adaptor cable provides you the option of adding a 3.5mm headphone jack on your new iPhone so you don't have to pack away your brilliant wired headphones



NEW	IPLT35	27727352	○	LIGHTNING TO 3.5MM SOCKET LEAD WITH CHARGING
NEW	8P35B	30254402	●	LIGHTNING TO 3.5MM SOCKET LEAD
NEW	8P35S	30254404	○	

KENSINGTON LOCK



This lap-lock consists of a simple lock and a metal cable which connect to the inbuilt security slot to a desk leg or secure

- Length of metal cable: 1.8m
- 4 figure – 10,000 combination codes



LAPLOK01 09009642

LAPTOP SECURITY LOCK

CLEANER KITS



CPK1 42735511

CLEANING & PROTECTIVE KIT

SIM CARD ADAPTORS

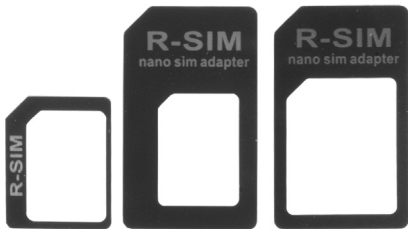

This pack of three SIM card adapters allow you to adapt your Nano and Micro SIM cards to Micro and Standard SIM sizes respectively.

- 1x Nano to Micro SIM adapter
- 1x Nano to Standard SIM adapter



NANOSIM1 43070240

NANO + MICRO SIM CARD ADAPTER

SIM CARD CUTTER



Easily cut your SIM card for use in your new iPhone and iPad or any other new phone or

3G/4G enabled tablet. Specially designed for cutting Standard SIM Cards to Nano SIM size.

- Features a simple, single motion cutting action
- Requires very little effort to cut
- Will not damage your SIM card when used correctly
- Includes 3-in-1 SIM card adaptor kit: 1) Nano to Micro 2) Nano to Standard & 3) Micro to Standard SIM adaptors



SIMCUT1 43070245

STANDARD TO NANO SIM CUTTER

5GDOCKB.....81	FL6Q-1.5PF.....46	HLV0975.....18	LA2033.....52	LC6160.....18	LC7149Y.....39	LV1501.....50	PK4610.....57	PRO1240.....53
7LDOCKG.....81	FL6Q-1.5PP.....49	HLV0976.....18	LA3013.....62	LC6162.....18	LC7150Y.....39	LV1560.....27	PK4640.....47	PRO1247D.....54
8P35B.....81	FL6Q-1.5PPW.....49	HLV0979.....18	LA3015.....62	LC6163.....18	LC7151Y.....39	LV5124.....53	PK4642.....50	PRO1247DS.....54
8P35S.....81	FL6Q-10CFF.....46	HLV0980.....18	LA3017.....62	LC6170.....19	LC7152Y.....39	LV5163.....63	PK4644.....63	PRO1247DSWP.....54
ADM5.....48	FL6Q-15CFF.....46	HLV0981.....15	LA3020.....62	LC6172.....19	LC7153Y.....39	LV5166.....63	PK4646.....63	PRO1254D.....55
AV212.....58	FL6Q-3CFF.....46	HLV0983.....15	LA3033.....62	LC6190.....19	LC7154Y.....39	LV5167.....63	PK4648.....63	PRO1255.....78
AV313.....58	FL6Q-3PF.....46	HLV0986.....15	LA3035.....62	LC6210.....13	LC7155Y.....39	LV5168.....63	PK4650.....63	PRO1256.....79
AV486.....58	FL6Q-5CFF.....46	HLV0987.....15	LA3037.....62	LC6216.....19	LC71600R.....39	LV5182.....27	PK4652.....63	PRO1257.....72
BMR3X.....67	FP7600.....22	HLV0989.....15	LA3038.....62	LC6500B.....40	LC71610R.....39	LV5184.....27	PK4654.....63	PRO1258A.....17
BNWP01.....74	FP7602.....22	HLV0991.....15	LA3041.....61	LC6502B.....40	LC7186.....32	LV5186.....56	PK4656.....73	PRO1259.....20
BNWP01B.....74	FP7604.....22	HLV0993.....15	LA3049.....60	LC6504B.....40	LC7188.....32	LV5188.....56	PK4658.....73	PRO1262.....20
CC0010/BLK.....41	FP7606.....22	HLV1130.....13	LA3061.....62	LC6506B.....40	LC7189.....32	LV5190.....56	PK4660.....73	PRO1270.....24
CHO1.....10	FP7608.....22	HLV1140.....15	LA3063.....62	LC6508B.....40	LC7190.....34	LV5192.....56	PK4662.....63	PRO1270S.....24
CPK1.....82	FP7620.....22	HLV1145.....13	LA3082.....62	LC6512B.....40	LC7195.....32	LV5194.....56	PK4664.....63	PRO1272.....74
CR85.....29	FP7622.....22	HLV1150.....13	LA3086.....62	LC6514B.....40	LC7200.....32	LV5196.....56	PK4666.....63	PRO1272B.....74
CSH01.....10	FP7624.....22	HLV1165.....13	LA3097.....62	LC6516B.....40	LC7203.....32	LV5198.....56	PK4668.....63	PRO1272D.....74
CVT201.....29	FP7640.....22	HLVF0.5.....12	LA3098.....62	LC6600B.....38	LC7210.....32	LV5200.....56	PK4670.....63	PRO1273.....74
DAC212.....20	FP7642.....22	HLVF1.....12	LA8000.....52	LC6603B.....38	LC7215.....34	MDA66B/IVY.....42	PK4672.....63	PRO1276.....55
DAC32.....20	FP7660.....22	HLVF2.....12	LA8012.....52	LC6606B.....38	LC7218.....34	MDA88B/IVY.....42	PK4674.....63	PRO1276WP.....55
DAD51.....20	FP7750.....22	HLVF3.....12	LAPL0K01.....82	LC6609B.....38	LC7222.....34	MHL2HDMI.....16	PK4678.....63	PRO1277.....28
DP2HDMI.....16	FP7770.....22	HLVF5.....12	LC0051B/BLK.....41	LC6612B.....38	LC7224.....34	NANOSIM1.....82	PK4684.....63	PRO1279.....28
H2SLO08/2+.....42	H2SPC5L.....6	HLVR10.....13	LC0051B/IVY.....41	LC6615B.....38	LC7225.....34	OTGMHLCR.....29	PK4688.....50	PRO1280.....28
EL59Q-0.3PP.....49	H4RX4.....5	HLVR15.....13	LC0056/IVY.....41	LC6618B.....38	LC7227.....32	P605DMB/IVY.....42	PK4690.....50	PRO1287.....20
EL59Q-1.5PP.....49	H4SPC5B.....5	HLVR20.....13	LC0056B/BLK.....41	LC6621B.....38	LC7230W.....39	PA005.....68	PK4694.....36	PRO1292.....78
EL59Q-10PP.....49	H4SPC5L.....6	HLVR30.....13	LC0076B/IVY.....41	LC6623B.....38	LC7231W.....39	PA1063.....65	PK4700.....17	PRO1294B.....79
EL59Q-1PP.....49	H8SPC5L.....6	HLVR40.....13	LC0091B/BLK.....41	LC6625B.....38	LC7232W.....39	PA1078WH.....65	PK4702.....17	PRO1296.....25
EL59Q-2PP.....49	HC01.....10	HR02.....16	LC0092/IVY.....41	LC6628R.....38	LC7233W.....39	PA1080BL.....65	PK4706.....17	PRO1297.....79
EL59Q-3PP.....49	HD02ECO.....10	HR04.....16	LC0095B/BLK.....41	LC6630R.....38	LC7234W.....39	PA1908.....21	PK4910.....17	PRO1298.....20
EL59Q-5PP.....49	HD4DCAD.....54	HUB3C4.....31	LC1000.....26	LC6633R.....38	LC7235W.....39	PA2295.....30	PK4912.....79	PRO1299.....68
ELHD005.....14	HDC6ECO.....5	HUB4.....31	LC1010.....26	LC6636R.....38	LC7236W.....39	PA2300.....36	PK4914.....79	PRO1300.....69
ELHD010.....14	HDC6L.....5	HV02.....15	LC1050.....25	LC6639R.....38	LC7237W.....39	PA2305.....36	PK4916.....79	PRO1309.....28
ELHD020.....14	HDC6WP.....5	HVY02.....10	LC1060.....25	LC6642R.....38	LC7241.....32	PA2310.....35	PNC616.....58	PRO1310.....17
ELHD030.....14	HDCP2214.....11	IFLASH32.....80	LC1070.....25	LC6645R.....38	LC7243.....32	PA2311.....36	PR3835.....50	PRO1314.....28
ELHDS005.....14	HDMI16SPEDID.....9	IFLASH64.....80	LC1080.....25	LC6648R.....38	LC7245.....34	PA2313.....35	PR3850.....47	PRO1323.....69
ELHH005.....14	HDMI1FLEX.....17	IFLASHMS.....80	LC1100.....25	LC6654G.....38	LC7251.....31	PA2316.....35	PR3860.....47	PRO1326.....77
ELHH010.....14	HDMI1H.....17	ILC66B/IVY.....42	LC1110.....25	LC6657G.....38	LC7256.....31	PA2319.....35	PR3870.....42	PRO1327.....67
ELHH015.....14	HDMI2FLEX.....17	ILC88B/IVY.....42	LC1120.....25	LC6660G.....38	LC7261.....31	PA2322.....35	PR3888.....50	PRO1328.....70
ELHH020.....14	HDMI2SP.....9	IP302WH.....33	LC1130.....25	LC6663G.....38	LC7266.....31	PA2325.....35	PRO1001.....71	PRO1328K.....70
ELHH030.....14	HDMI2SPEC0.....9	IPDAU.....33	LC1140.....25	LC6666G.....38	LC7360.....80	PA2328.....35	PRO1022.....71	PRO1328WP.....70
ELHH050.....14	HDMI3S4K.....9	IPEX12.....80	LC1150.....25	LC6669G.....38	LC7500BK.....38	PA2331.....35	PRO1024.....74	PRO1330.....78
ELHH075.....14	HDMI3SM.....9	IPHCAR.....81	LC1160.....25	LC6672G.....38	LC7502BK.....38	PA2334.....35	PRO1024B.....73	PRO1338.....24
ELHH100.....14	HDMI4.....8	IPLC1GD.....33	LC1210.....26	LC6675G.....38	LC7504BK.....38	PA2337.....35	PRO1030.....72	PRO1340.....68
ELHHS005.....14	HDMI4AVR.....8	IPLC1GRAY.....33	LC1220.....26	LC6681Y.....38	LC7506BK.....38	PA2340.....35	PRO1032.....72	PRO1343.....68
ELHHS010.....14	HDMI4SP.....9	IPLC1SLV.....33	LC1230.....26	LC6684Y.....38	LC7508BK.....38	PA2343.....35	PRO1034.....72	PRO1345.....17
ELHHS020.....14	HDMI5SM.....9	IPLT35.....81	LC1250.....26	LC6687Y.....38	LC7510BK.....38	PA2346.....35	PRO1044.....72	PRO1348.....52
ELHHS030.....14	HDMI8SPEDID.....9	IRE12.....77	LC1260.....26	LC6690Y.....38	LC7512BK.....38	PA4220.....53	PRO1047.....56	PRO1351.....67
ERM4015B/WHT.....41	HDMIFIB.....7	IRE12SPT.....77	LC1270.....26	LC6693Y.....38	LC7514BK.....38	PA4245.....18	PRO1048.....58	PRO1351WP.....67
ESATA50.....43	HDMIIPPRO.....4	ISHUFFLE2USB.....33	LC1280.....26	LC6696Y.....38	LC7520BL.....38	PA4250.....18	PRO1059.....64	PRO1354.....29
EU275P.....50	HDMIIPPRORX.....4	LA0469.....21	LC1290.....26	LC6699Y.....38	LC7522BL.....38	PA4270.....16	PRO1117.....56	PRO1358.....70
FIB100M.....22	HDMIKVM.....4	LA0470.....21	LC1300.....26	LC6702Y.....38	LC7524BL.....38	PA4275.....16	PRO1121.....61	PRO1362D.....21
FIB1000D.....22	HDMIMX42ARC.....10	LA0471.....21	LC1310.....26	LC6735W.....38	LC7526BL.....38	PA4280.....16	PRO1140.....78	PRO1376.....21
FIB100SF.....22	HDMIMX4422.....10	LA0473.....21	LC1370.....25	LC6738W.....38	LC7528BL.....38	PA4295.....16	PRO1141.....78	PRO3420.....17
FIB150M.....22	HDMIMX44RS.....10	LA0474.....21	LC1380.....25	LC6741W.....38	LC7530BL.....38	PA4300.....15	PRO1142.....78	PRO3425.....17
FIB200M.....22	HDMIRG6.....7	LA0477.....21	LC1400.....25	LC6744W.....38	LC7532BL.....38	PA4305.....28	PRO1143.....72	REVBWP.....74
FIB250M.....22	HDMIRG6S.....7	LA0478.....21	LC1410.....25	LC6747W.....38	LC7534BL.....38	PA4310.....28	PRO1144.....72	RFD2169.....48
FIB300M.....22	HDCV01.....12	LA0480.....21	LC1420.....25	LC6750W.....38	LC7536BL.....38	PA4350.....16	PRO1144A.....72	RFD2169BF.....45
FL59Q-0.3FF.....46	HE01.....11	LA1030.....65	LC1500.....26	LC6753W.....38	LC7538BL.....38	PA4355.....18	PRO1153.....73	RFD2169IR.....48
FL59Q-0.5CFF.....46	HLA8050.....61	LA1031.....65	LC1510.....26	LC6756W.....38	LC7805.....33	PA4360.....19	PRO1161.....72	RFMX3.....45
FL59Q-0.5PF.....46	HLA8070.....52	LA1033.....65	LC1530.....26	LC6915.....40	LC7815.....33	PA4365.....16	PRO1163P.....72	RFMX3IR.....45
FL59Q-0.5PP.....49	HLA8073.....52	LA1035.....65	LC1540.....26	LC7100B.....39	LC7825.....33	PA4370.....16	PRO1169.....55	RFMX3IRST.....45
FL59Q-0.5PPW.....49	HLA8076.....52	LA1039.....65	LC1550.....26	LC7102B.....39	LC7855.....33	PA4390.....80	PRO1170.....55	SATA45.....43
FL59Q-1.5FF.....46	HLA8079.....52	LA1042.....65	LC2010.....27	LC7104B.....39	LC7865.....33	PD2920.....64	PRO1177.....59	SC4K2K.....11
FL59Q-1.5PF.....46	HLA8080.....64	LA1044.....65	LC2012.....27	LC7106B.....39	LH0328.....61	PK3304.....17	PRO1178A.....78	SIMCUT1.....82
FL59Q-1.5PP.....49	HLDS0.5M.....12	LA1045.....65	LC2025.....27	LC7112B.....39	LH0775.....57	PK3307.....28	PRO1178A.....78	SM166B/WHT.....42
FL59Q-10PP.....49	HLDS0.5W.....12	LA1048.....62	LC5081.....43	LC7114B.....39	LPBNWP.....74	PK3309.....28	PRO1183.....78	SPC5RX.....6
FL59Q-1CFF.....46	HLDS1M.....12	LA1050.....62	LC5085.....43	LC7118B.....39	LV0780.....57	PK4040.....40	PRO1185.....9	SPF.....45
FL59Q-1FF.....46	HLDS1W.....12	LA1051.....62	LC5086.....43	LC7122B.....39	LV0784.....57	PK4045.....40	PRO1188A.....76	SPS2A.....71
FL59Q-1PF.....46	HLDS2M.....12	LA1052.....62	LC5090.....43	LC7125B.....39	LV0787.....57	PK4550.....73	PRO1188AS.....76	SPS4.....71
FL59Q-1PP.....49	HLDS2W.....12	LA1053.....62	LC5093.....43	LC7127B.....39	LV1002.....60	PK4570.....73	PRO1191.....72	SPS6.....71
FL59Q-1PPW.....49	HLDS3M.....12	LA1055.....62	LC6037.....43	LC7138G.....39	LV1004.....60	PK4575.....73	PRO1199.....59	UNIDOCKB.....81
FL59Q-2CFF.....46	HLDS3W.....12	LA1057.....62	LC6090.....28	LC7139G.....39	LV1005.....60	PK4576.....73	PRO1200.....55	UNIDOCKW.....81
FL59Q-2FF.....46	HLV0909.....55	LA1059.....62	LC6092.....28	LC7140G.....39	LV1006.....60	PK4578.....73	PRO1211.....59	UPRS2.....30
FL59Q-2PF.....46	HLV0915.....55	LA1061.....62	LC6094.....18	LC7141G.....39	LV1008.....50	PK4580.....73	PRO1218.....55	UPRS3.....30
FL59Q-2PP.....49	HLV0930.....57	LA1063.....65	LC6096.....18	LC7142G.....39	LV1110.....60	PK4582.....73	PRO1221.....59	USB3HDMI.....11
FL59Q-2PPW.....49	HLV0933.....57	LA1065.....65	LC6098.....27	LC7143G.....39	LV1115.....60	PK4584.....73	PRO1235D.....59	USB-DB25.....30
FL59Q-3PP.....49	HLV0969.....18	LA1077.....60	LC6150.....13	LC7144G.....39	LV1117.....60	PK4586.....73	PRO1235DS.....59	USB-RS232.....30
FL59Q-3PPW.....49	HLV0970.....18	LA1081.....63	LC6152.....13	LC7145G.....39	LV1120.....60	PK4588.....73	PRO1235DSWP.....59	VH03.....10
FL59Q-5PP.....49	HLV0973.....18	LA1092.....64	LC6152.....13	LC7148Y.....39	LV1495.....50	PK4601.....47	PRO1237.....36	YH02.....10

MODULAR WALL PLATE INSERTS

STEP 1

Grab the MW13FR blank frame

STEP 2

Choose up to 3 modules to make

the exact wall plate you need

EASY!

At Pro2, we understand that each job is different and each setup is unique. So that's why we created the MW13 modular wall plate range.

Need 2 HDMI sockets and a Foxtel point on the wall? No problem, just pick your parts and assemble your own. Need to replace an old USB2 port with USB3? Just swap out the old one and replace it with the new without touching any other connector. With our modular design you can simply mix and match up two 3 modules to suit your needs. They snap on tightly and securely giving a perfect finish, each time.



Mix and match 3 modules and create your own design!

RCA



STEREO MODULE 2x RCA
 MW113RCA2 | 30634810

PAL



PAL TO 'F' MODULE
 1x PAL MW113PF | 30634825

VGA

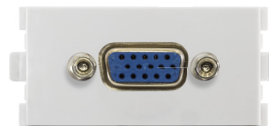

VGA MODULE 1x DB15
 MW113VGA | 30634860

EVEN MORE MODULES AVAILABLE INCLUDING DVI, FOXTEL, USB, CAT5E AND MORE

USB



USB B MODULE 1x USB B
 MW113USBB | 30634869

USB 3.0



USB 3.0 MODULE 1x USB 3.0
 MW113USB3 | 30634867

HDMI



HDMI MODULE 1x HDMI
 MW113HDMI | 30634870

BNC

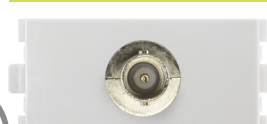

BNC MODULE 1x BNC
 MW113BNC | 30634880



CALL 1800 337 366
 FOR PRO2 SUPPORT



VISIT PRO2.COM.AU
 FOR PRO2 PRODUCT MANUALS,
 INFO-SHEETS AND DEALER LIST

TERMS & CONDITIONS Product features in this brochure are subject to change without notice. Availability of products are offered on a while stocks last basis. Most products have been photographed in-house and are identical to what you will receive, but manufacturers may make improvements during the life of a product without notice and this may result in a slightly different design. If certain product features are important, please contact the dealer for confirmation before ordering the product. Information presented in this brochure has been checked and is believed to be correct at the time of printing, however, errors and omissions are accepted. PRO2 can not guarantee specifications, or features of a product as they may change after printing.

